

EDITION / VERSİYON
UPDATE / GÜNCELLEME

05/2019
07/2021

SLIDING SYSTEM
SÜRME SİSTEMİ
SYSTEM 38T
SİSTEM 38T

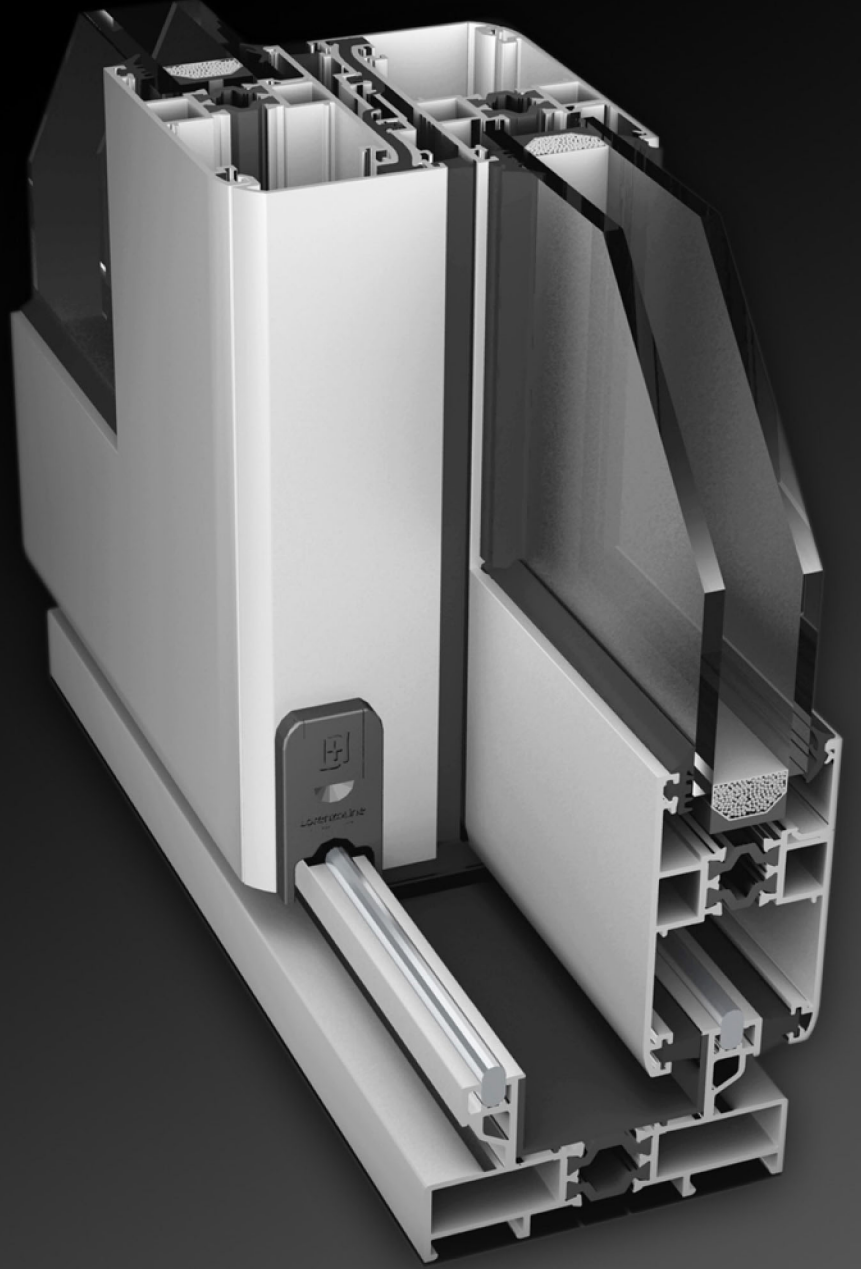

38T SYSTEM / SİSTEM
TECHNICAL INFORMATION / TEKNİK BİLGİLER

System Properties / Sistem Özellikleri

Frame Height / Kasa Genişliği	: 77.4 mm
Vent Height / Kanat Genişliği	: 38 mm
Wall Thickness / Et Kalınlığı	: 1.4 - 1.5 mm
Insulation Bar / Isı Bariyer	: 14.8 mm
Sash Carrying Capacity Kanat Taşıma Kapasitesi	: 120 Kg
Thermal Permeability Uf Isı Geçirgenlik Uf EN ISO 1077-2	: 4.45 W/m ² K
EPDM Gaskets / EPDM Fıtil	
Glazing From 4 mm to 24 mm Cam Kullanımı 4 mm'den 24 mm	
Compatible with 60T / 60T ile Uyumlu	

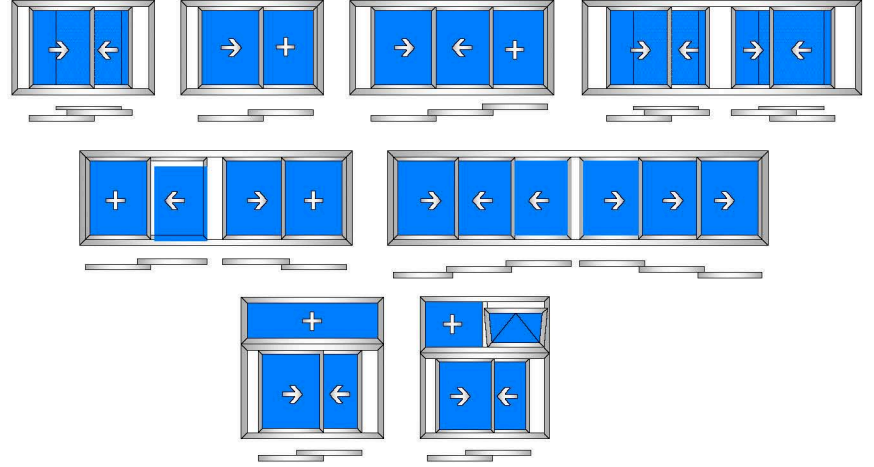
Sliding Opportunities / Sürme Seçenekleri**Code Logic / Kod Mantığı**

38T	101	00
Title / Seri	Group / Grup	Factory Standard Fabrika Standardı

Titles / Seriler

38T - System Name / Sistem Adı
08 - Glazing Bead / Cam Çıtası
09 - Extruded Corner Joints / Pres Köşe Takoğu

Groups / Gruplar

101, 102, ... Frames / Kasalar
201, 211, ... Vents / Kanatlar
301, 302, ... Mullions / Orta Kayıtlar
411, 412, ... Narrow Profiles / Dar Kenet
501, 502, ... Adapters / Adaptörler

Alloy / Alaşım

The alloys of the aluminium profiles are 6060 and 6063 (AlMgSi 0,5 - F22) based on EN 12020-2 / 755-9 standards. Alüminyum profil alaşımları 6060 ve 6063 (AlMgSi 0,5 - F22) EN 12020-2 / 755-9 standartlarına uygundur.

All drawings are not scaled.
Tüm çizimler ölçeksizdir.

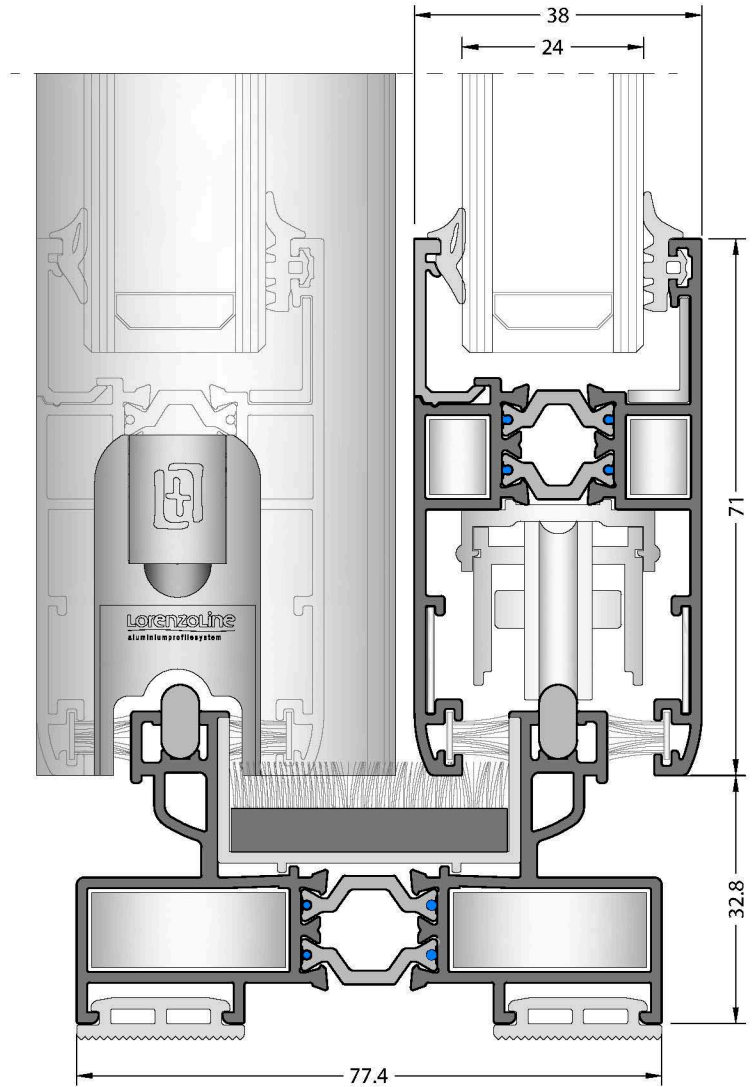

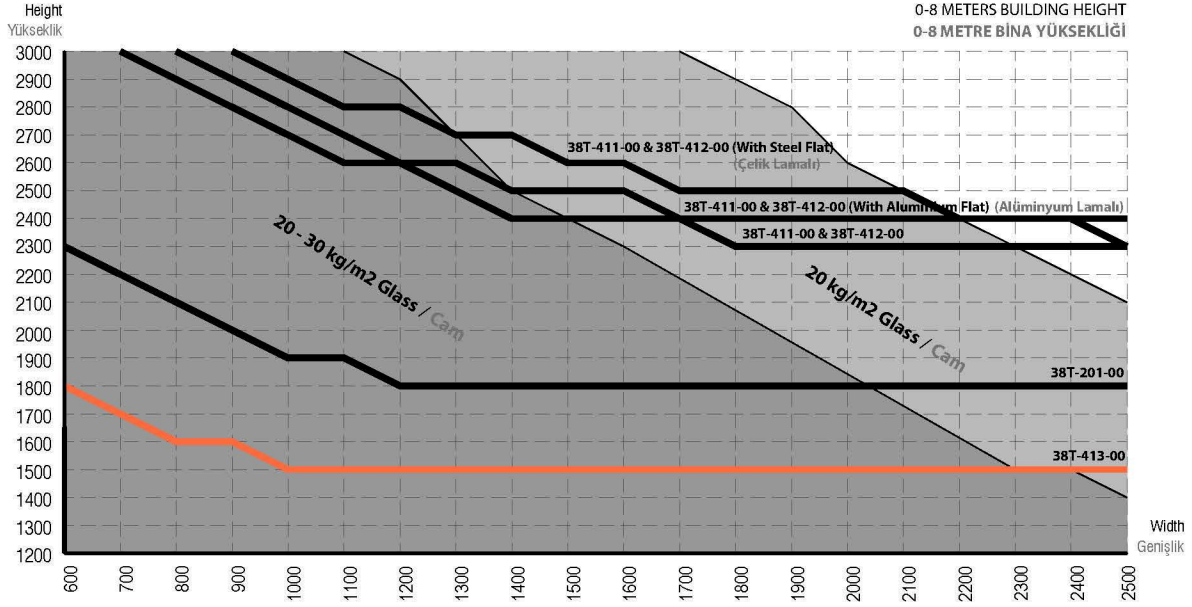
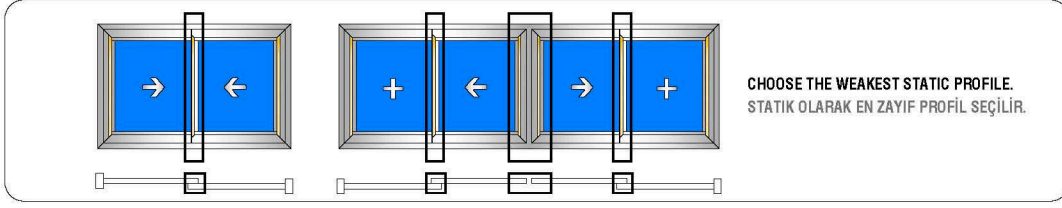

- 38T-411-00 & 38T-412-00 (0-8 meters Building Height) (With Steel Flat)
(0-8 metre Bina Yüksekliği) (Çelik Lamalı)
- 38T-411-00 & 38T-412-00 (0-8 meters Building Height) (With Aluminium Flat)
(0-8 metre Bina Yüksekliği) (Alüminyum Lamalı)
- 38T-411-00 & 38T-412-00 (0-8 meters Building Height)
(0-8 metre Bina Yüksekliği)
- 38T-201-00
(0-8 meters Building Height)
(0-8 metre Bina Yüksekliği)
- 38T-413-00
(0-8 metre Bina Yüksekliği)

- 20 kg/m2 Glass Area
Cam Alanı
- 30 kg/m2 Glass Area
Cam Alanı

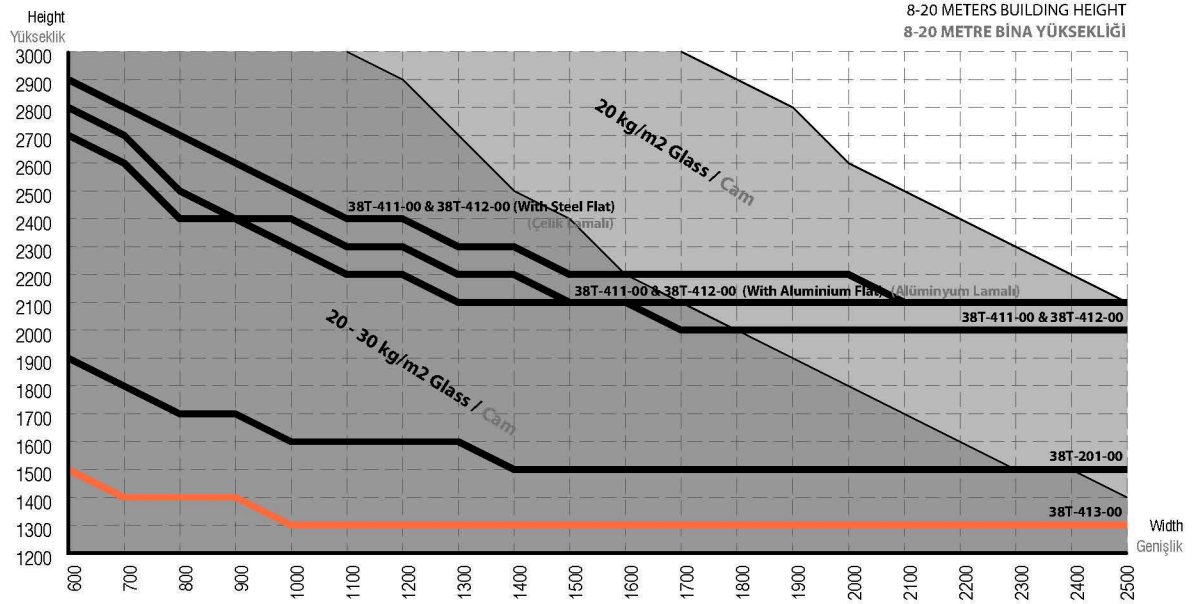

- 38T-411-00 & 38T-412-00 (8-20 meters Building Height) (With Steel Flat)
(8-20 metre Bina Yüksekliği) (Çelik Lamalı)
- 38T-411-00 & 38T-412-00 (8-20 meters Building Height) (With Aluminium Flat)
(8-20 metre Bina Yüksekliği) (Alüminyum Lamalı)
- 38T-411-00 & 38T-412-00 (8-20 meters Building Height)
(8-20 metre Bina Yüksekliği)
- 38T-201-00
(8-20 meters Building Height)
(8-20 metre Bina Yüksekliği)
- 38T-413-00
(8-20 meters Building Height)
(8-20 metre Bina Yüksekliği)

- 20 kg/m2 Glass Area
Cam Alanı
- 30 kg/m2 Glass Area
Cam Alanı

**38T SYSTEM / SÍSTEM
PROFILES / PROFÍLLER**

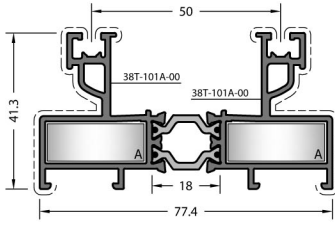

CODE / KOD
38T-101-00

CORNER JOINTS
KÖŞE BAĞLANTILAR

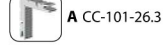

THEORETICAL WEIGHT kg/m
TEORİK AĞIRLIK kg/m
1.462

DIE-CAST CORNER JOINT
PİMLİ BAĞLANTI

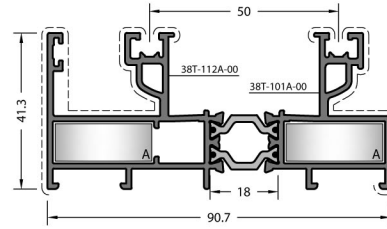

CODE / KOD
38T-112-00

CORNER JOINTS
KÖŞE BAĞLANTILAR



THEORETICAL WEIGHT kg/m
TEORİK AĞIRLIK kg/m
1.707

DIE-CAST CORNER JOINT
PİMLİ BAĞLANTI

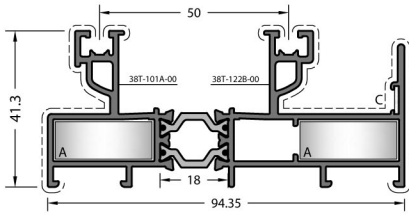

CODE / KOD
38T-122-00

CORNER JOINTS
KÖŞE BAĞLANTILAR



THEORETICAL WEIGHT kg/m
TEORİK AĞIRLIK kg/m
1.710

DIE-CAST CORNER JOINT
PİMLİ BAĞLANTI

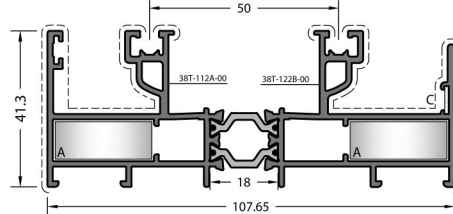

CODE / KOD
38T-132-00

CORNER JOINTS
KÖŞE BAĞLANTILAR



THEORETICAL WEIGHT kg/m
TEORİK AĞIRLIK kg/m
1.955

DIE-CAST CORNER JOINT
PİMLİ BAĞLANTI

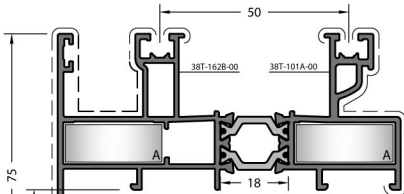

CODE / KOD
38T-162-00

CORNER JOINTS
KÖŞE BAĞLANTILAR



THEORETICAL WEIGHT kg/m
TEORİK AĞIRLIK kg/m
1.773

DIE-CAST CORNER JOINT
PİMLİ BAĞLANTI

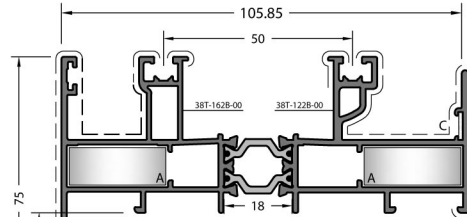

CODE / KOD
38T-172-00

CORNER JOINTS
KÖŞE BAĞLANTILAR



THEORETICAL WEIGHT kg/m
TEORİK AĞIRLIK kg/m
2.021

DIE-CAST CORNER JOINT
PİMLİ BAĞLANTI

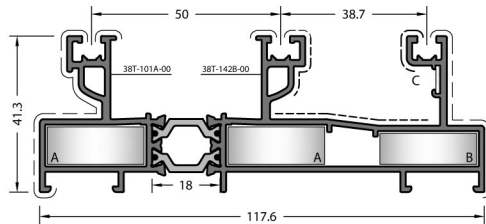

CODE / KOD
38T-142-00

CORNER JOINTS
KÖŞE BAĞLANTILAR



THEORETICAL WEIGHT kg/m
TEORİK AĞIRLIK kg/m
1.982

DIE-CAST CORNER JOINT
PİMLİ BAĞLANTI

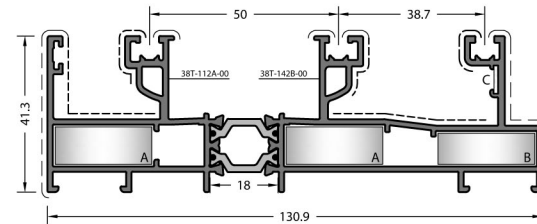

CODE / KOD
38T-152-00

CORNER JOINTS
KÖŞE BAĞLANTILAR



THEORETICAL WEIGHT kg/m
TEORİK AĞIRLIK kg/m
2.226

DIE-CAST CORNER JOINT
PİMLİ BAĞLANTI



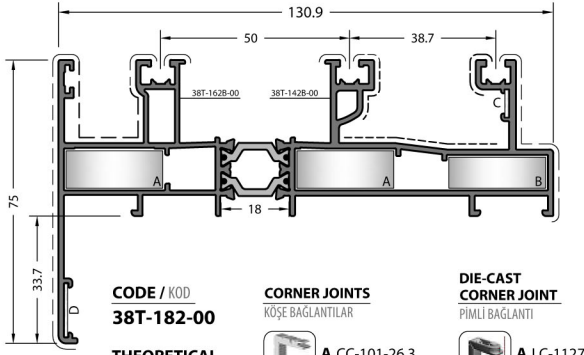

CODE / KOD
38T-182-00

THEORETICAL WEIGHT kg/m
TEORİK AĞIRLIK kg/m
2.292

CORNER JOINTS
KÖŞE BAĞLANTILAR

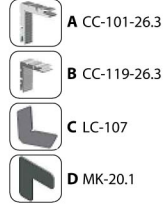

DIE-CAST CORNER JOINT
PİMLİ BAĞLANTI

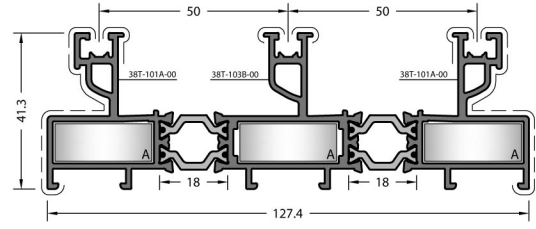

CODE / KOD
38T-103-00

THEORETICAL WEIGHT kg/m
TEORİK AĞIRLIK kg/m
2.350

CORNER JOINTS
KÖŞE BAĞLANTILAR



DIE-CAST CORNER JOINT
PİMLİ BAĞLANTI

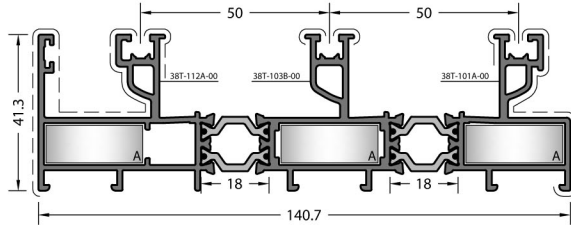

CODE / KOD
38T-113-00

THEORETICAL WEIGHT kg/m
TEORİK AĞIRLIK kg/m
2.595

CORNER JOINTS
KÖŞE BAĞLANTILAR



DIE-CAST CORNER JOINT
PİMLİ BAĞLANTI

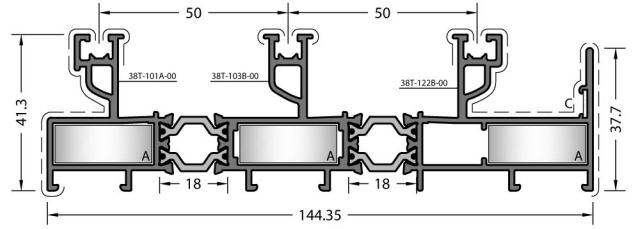

CODE / KOD
38T-123-00

THEORETICAL WEIGHT kg/m
TEORİK AĞIRLIK kg/m
2.598

CORNER JOINTS
KÖŞE BAĞLANTILAR



DIE-CAST CORNER JOINT
PİMLİ BAĞLANTI

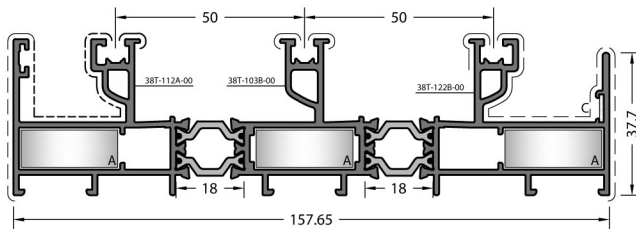

CODE / KOD
38T-133-00

THEORETICAL WEIGHT kg/m
TEORİK AĞIRLIK kg/m
2.843

CORNER JOINTS
KÖŞE BAĞLANTILAR

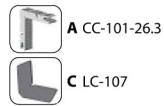

DIE-CAST CORNER JOINT
PİMLİ BAĞLANTI

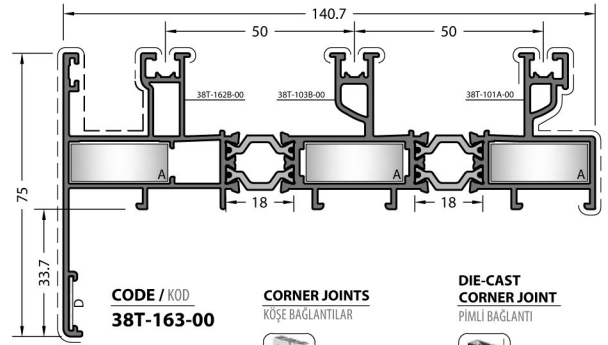

CODE / KOD
38T-163-00

THEORETICAL WEIGHT kg/m
TEORİK AĞIRLIK kg/m
2.661

CORNER JOINTS
KÖŞE BAĞLANTILAR

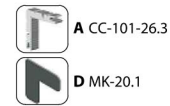

DIE-CAST CORNER JOINT
PİMLİ BAĞLANTI

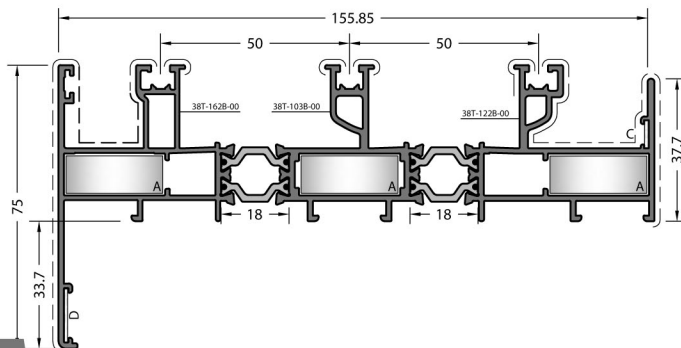

CODE / KOD
38T-173-00

THEORETICAL WEIGHT kg/m
TEORİK AĞIRLIK kg/m
2.909

CORNER JOINTS
KÖŞE BAĞLANTILAR

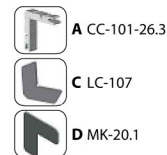

DIE-CAST CORNER JOINT
PİMLİ BAĞLANTI



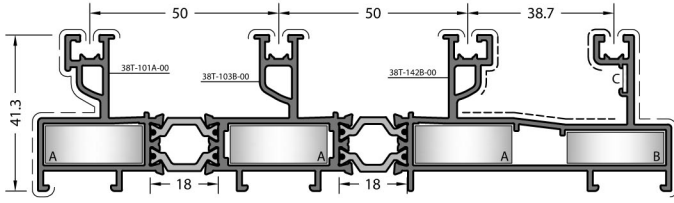

CODE / KOD
38T-143-00

THEORETICAL WEIGHT kg/m
TEORİK AĞIRLIK kg/m
2.870

CORNER JOINTS
KÖŞE BAĞLANTILAR



DIE-CAST CORNER JOINT
PİMLİ BAĞLANTI

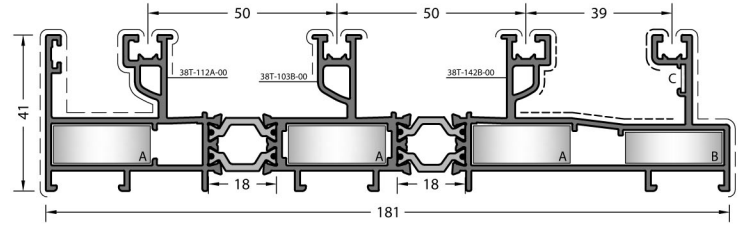

CODE / KOD
38T-197-00

THEORETICAL WEIGHT kg/m
TEORİK AĞIRLIK kg/m
3.114

CORNER JOINTS
KÖŞE BAĞLANTILAR



DIE-CAST CORNER JOINT
PİMLİ BAĞLANTI

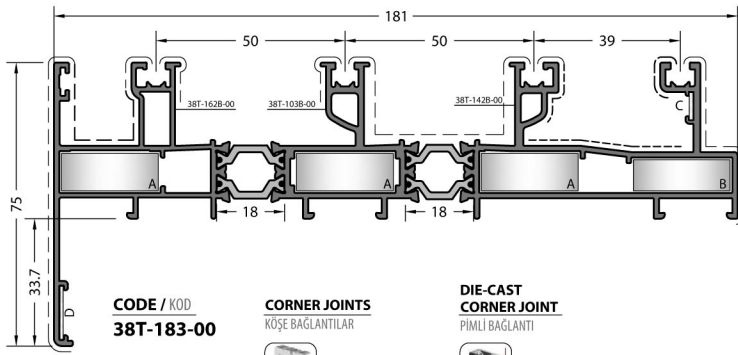

CODE / KOD
38T-183-00

THEORETICAL WEIGHT kg/m
TEORİK AĞIRLIK kg/m
3.180

CORNER JOINTS
KÖŞE BAĞLANTILAR

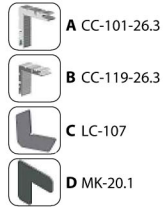

DIE-CAST CORNER JOINT
PİMLİ BAĞLANTI

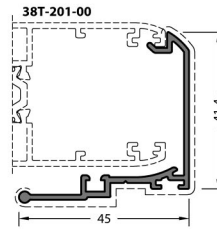

CODE / KOD
38-502-00

THEORETICAL WEIGHT kg/m
TEORİK AĞIRLIK kg/m
0.425

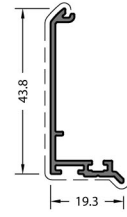

CODE / KOD
38T-512-00

THEORETICAL WEIGHT kg/m
TEORİK AĞIRLIK kg/m
0.275

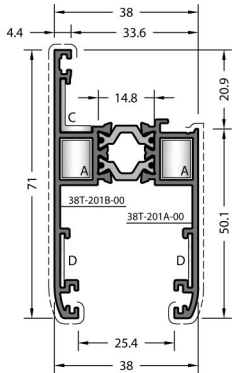

CODE / KOD
38T-201-00

THEORETICAL WEIGHT kg/m
TEORİK AĞIRLIK kg/m
1.113

CORNER JOINTS
KÖŞE BAĞLANTILAR

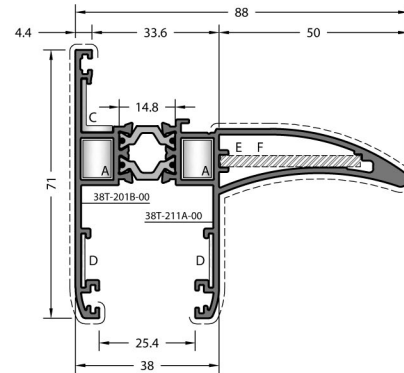
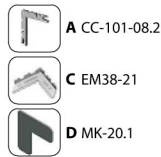

CODE / KOD
38T-211-00

THEORETICAL WEIGHT kg/m
TEORİK AĞIRLIK kg/m
1.611

CORNER JOINTS
KÖŞE BAĞLANTILAR

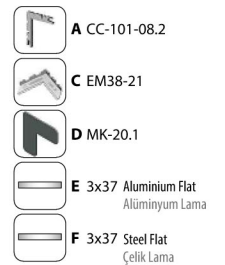

CODE / KOD
38-801-00

THEORETICAL WEIGHT kg/m
TEORİK AĞIRLIK kg/m
0.133

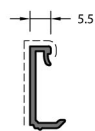

CODE / KOD
38-802-00

THEORETICAL WEIGHT kg/m
TEORİK AĞIRLIK kg/m
0.141

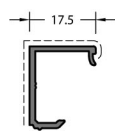

CODE / KOD
38-807-00

THEORETICAL WEIGHT kg/m
TEORİK AĞIRLIK kg/m
0.184

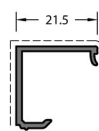

CODE / KOD
38-808-00

THEORETICAL WEIGHT kg/m
TEORİK AĞIRLIK kg/m
0.197

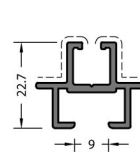

CODE / KOD
38-503-00

THEORETICAL WEIGHT kg/m
TEORİK AĞIRLIK kg/m
0.371

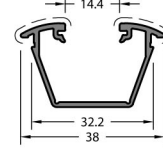

CODE / KOD
38C-513-00

THEORETICAL WEIGHT kg/m
TEORİK AĞIRLIK kg/m
0.320

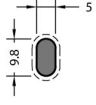

5 Micron Anodized.
5 Mikron Eloksal.

CODE / KOD
13-134-050R

THEORETICAL WEIGHT kg/m
TEORİK AĞIRLIK kg/m
0.118

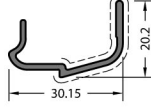

CODE / KOD
38T-510-00

THEORETICAL WEIGHT kg/m
TEORİK AĞIRLIK kg/m
0.233

CAP KAPAK



EM38T-510

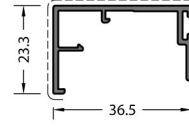

CODE / KOD
38T-521-00

THEORETICAL WEIGHT kg/m
TEORİK AĞIRLIK kg/m
0.352

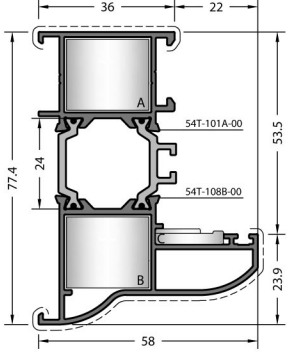

CODE / KOD
60T-108-00

THEORETICAL WEIGHT kg/m
TEORİK AĞIRLIK kg/m
1.381

CORNER JOINTS
KÖŞE BAĞLANTILAR

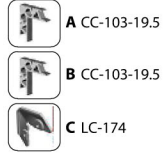

DIE-CAST CORNER JOINT
PİMLİ BAĞLANTI

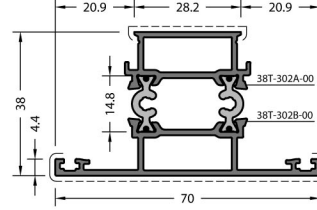

CODE / KOD
38T-302-00

THEORETICAL WEIGHT kg/m
TEORİK AĞIRLIK kg/m
1.077

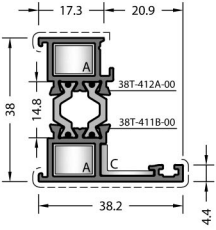

CODE / KOD
38T-413-00

THEORETICAL WEIGHT kg/m
TEORİK AĞIRLIK kg/m
0.729

CORNER JOINTS
KÖŞE BAĞLANTILAR

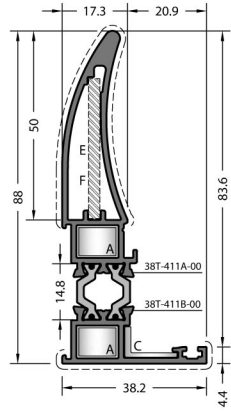
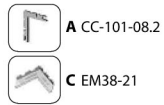

CODE / KOD
38T-411-00

THEORETICAL WEIGHT kg/m
TEORİK AĞIRLIK kg/m
1.227

CORNER JOINTS
KÖŞE BAĞLANTILAR

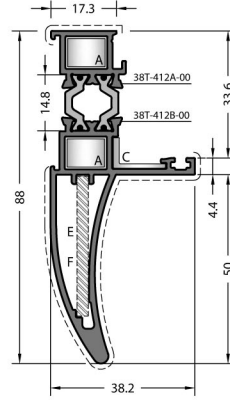
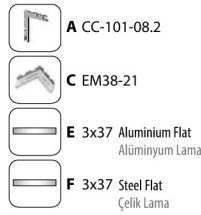

CODE / KOD
38T-412-00

THEORETICAL WEIGHT kg/m
TEORİK AĞIRLIK kg/m
1.226

CORNER JOINTS
KÖŞE BAĞLANTILAR

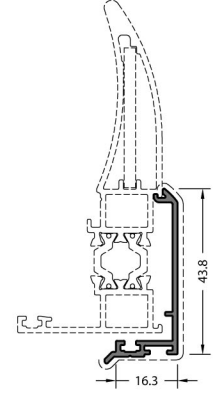
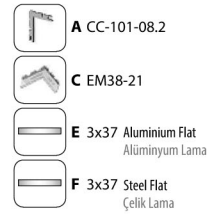

CODE / KOD
38T-512-00

THEORETICAL WEIGHT kg/m
TEORİK AĞIRLIK kg/m
0.275

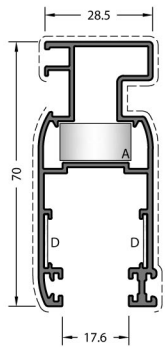

CODE / KOD
38T-251-00

THEORETICAL WEIGHT kg/m
TEORİK AĞIRLIK kg/m
0.920

CORNER JOINTS
KÖŞE BAĞLANTILAR

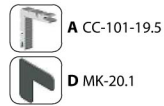

DIE-CAST CORNER JOINT
PİMLİ BAĞLANTI

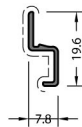

CODE / KOD
38T-252-00

THEORETICAL WEIGHT kg/m
TEORİK AĞIRLIK kg/m
0.084

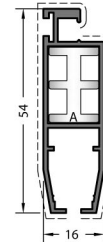

CODE / KOD
1621

THEORETICAL WEIGHT kg/m
TEORİK AĞIRLIK kg/m
0.498

CORNER JOINTS
KÖŞE BAĞLANTILAR



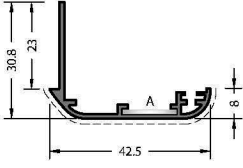

CODE / KOD
07-102-00

THEORETICAL
WEIGHT kg/m
TEORİK AĞIRLIK kg/m
0.324

CORNER JOINTS
KÖŞE BAĞLANTILAR

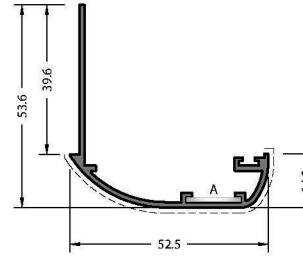

CODE / KOD
07-103-00

THEORETICAL
WEIGHT kg/m
TEORİK AĞIRLIK kg/m
0.488

CORNER JOINTS
KÖŞE BAĞLANTILAR

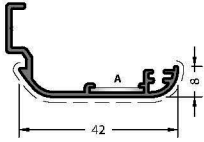

CODE / KOD
07-106-00

THEORETICAL
WEIGHT kg/m
TEORİK AĞIRLIK kg/m
0.318

CORNER JOINTS
KÖŞE BAĞLANTILAR

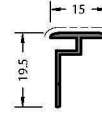

CODE / KOD
07-201-00

THEORETICAL
WEIGHT kg/m
TEORİK AĞIRLIK kg/m
0.118

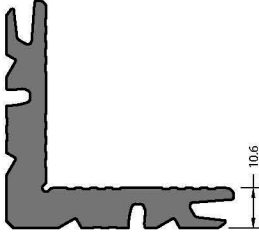

Mill Finish / Pres
No visible surface.
Görünen yüzeyi yoktur.

CODE / KOD
09-101-00

THEORETICAL
WEIGHT kg/m
TEORİK AĞIRLIK kg/m
2.561

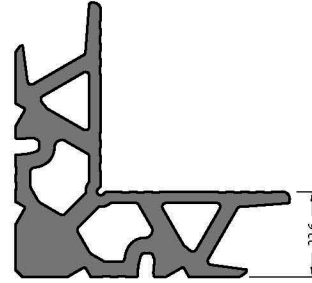

Mill Finish / Pres
No visible surface.
Görünen yüzeyi yoktur.

CODE / KOD
09-103-00

THEORETICAL
WEIGHT kg/m
TEORİK AĞIRLIK kg/m
3.689

**38T SYSTEM / SİSTEM
DETAILS / DETAYLAR**

Pvc Sliding Espagnolette
Pvc Sürme İspanyolet

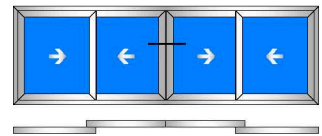
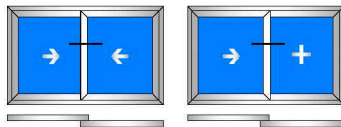
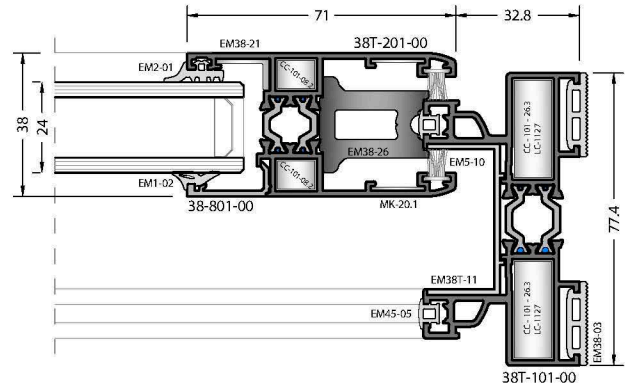
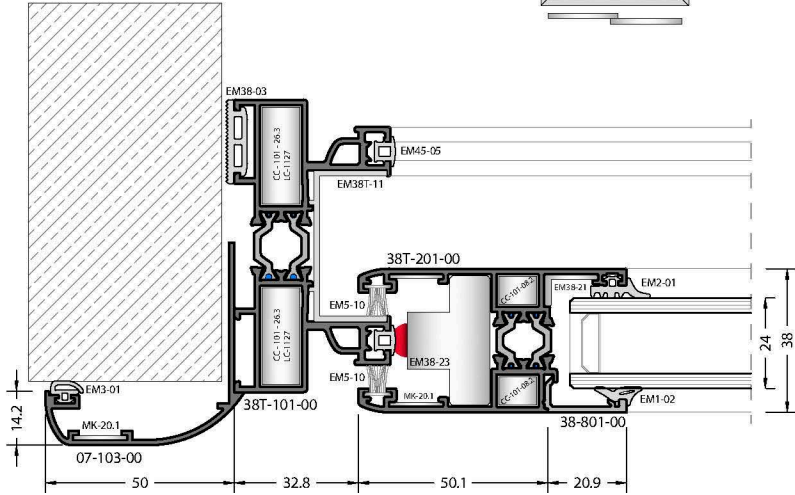
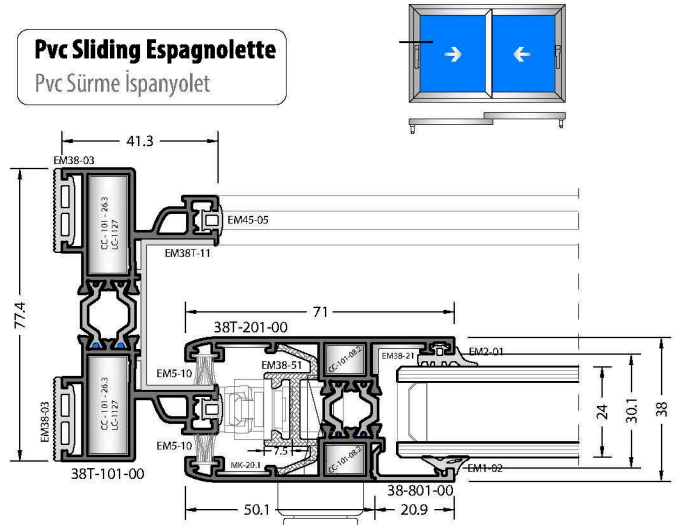
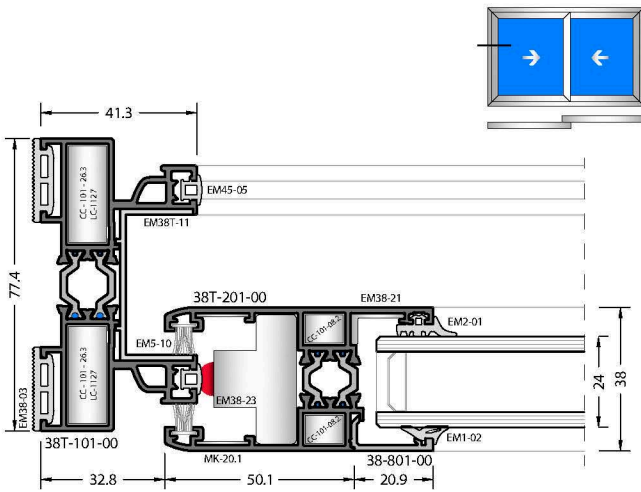

STANDARD / STANDART

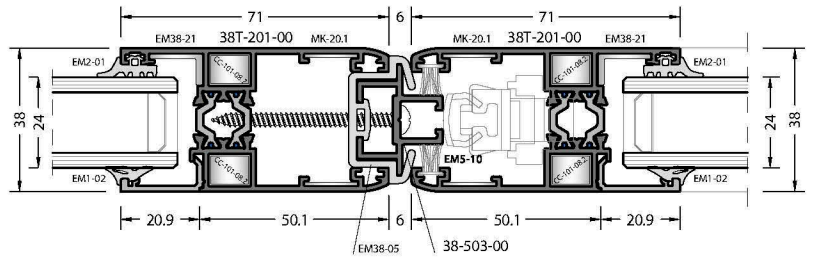
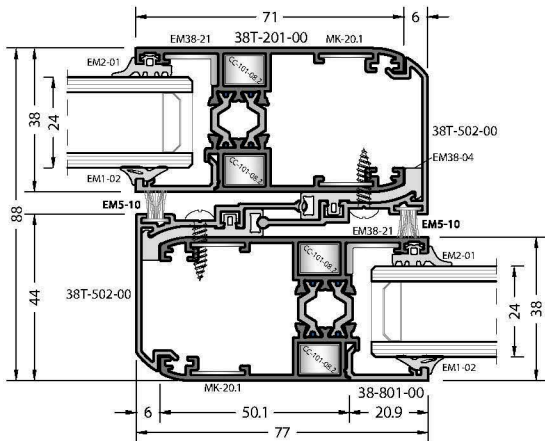

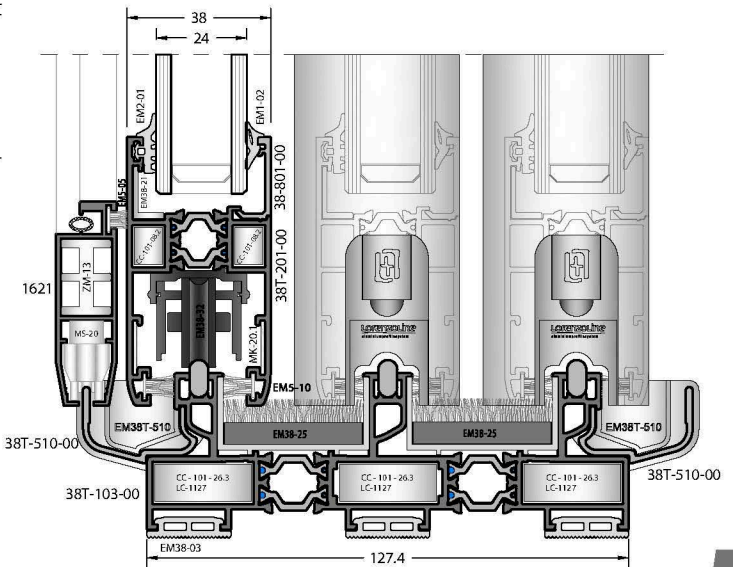
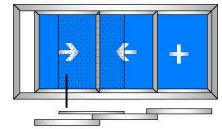
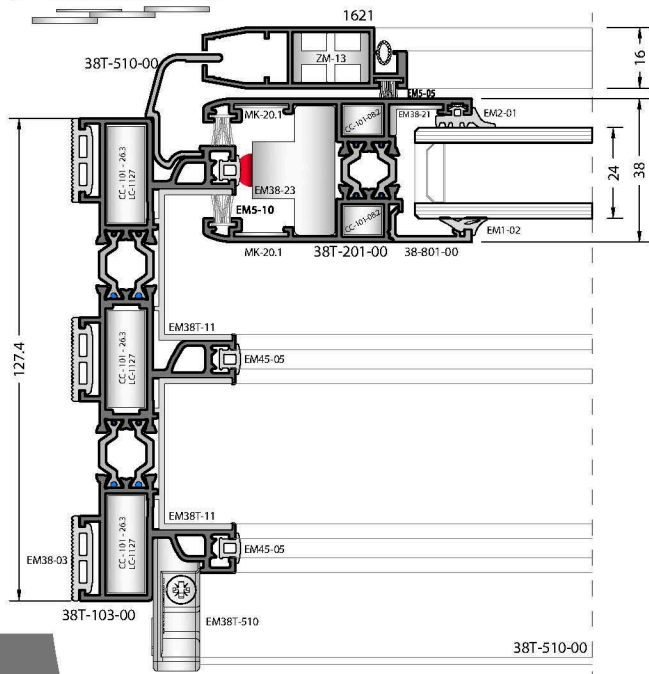
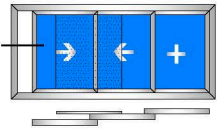
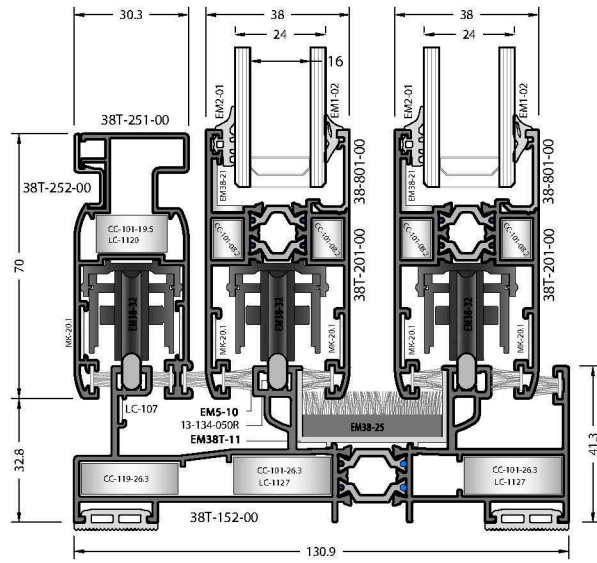
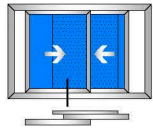
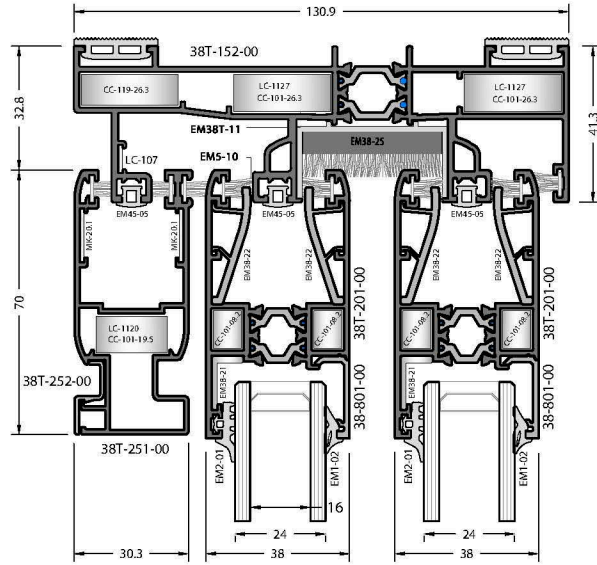
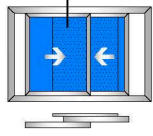

1:2 Scaled / 1:2 Ölçek

**38T SYSTEM / SİSTEM
ACCESSORIES / AKSESUARLAR**

GLAZING TABLE / CAM TABLOSU

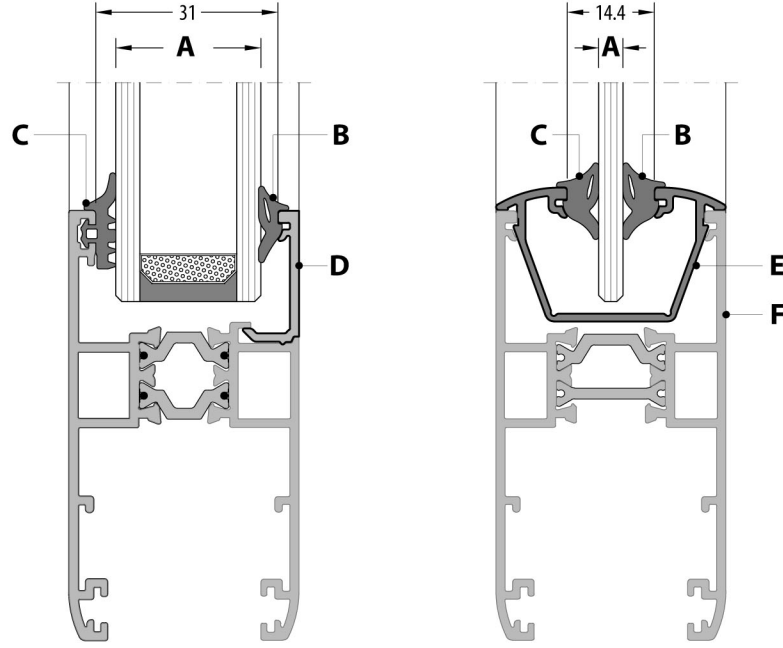

A	B	C	D	E	F
GLAZING THICKNESS CAM KALINLIĞI	INSIDE GLASS GASKET İÇ CAM FİTİLİ	OUTSIDE GLASS GASKET DIŞ CAM FİTİLİ	GLAZING BEAD CAM ÇİTASI	ADAPTER ADAPTÖR	SASH KANAT
4 mm	EM1-04	EM2-01	38-808-00	-	38T-201-00 38T-211-00
		EM1-04	-	38C-513-00	38T-202-00
5 mm	EM1-03	EM2-01	38-808-00	-	38T-201-00 38T-211-00
6 mm	EM1-03	EM1-03	-	38C-513-00	38T-202-00
	EM1-02	EM2-01	38-808-00	-	38T-201-00 38T-211-00
8 mm	EM1-02	EM1-02	-	38C-513-00	38T-202-00
	EM1-04	EM2-01	38-807-00	-	38T-201-00 38T-211-00
9 mm	EM1-03	EM2-01	38-807-00	-	38T-201-00 38T-211-00
10 mm	EM1-02	EM2-01	38-807-00	-	38T-201-00 38T-211-00
20 mm	EM1-05	EM1-04	-	-	38T-202-00
	EM1-04	EM2-01	38-802-00	-	38T-201-00 38T-211-00
22 mm	EM1-04	EM1-03	-	-	38T-202-00
		EM2-01	38-801-00	-	38T-201-00 38T-211-00
24 mm	EM1-03	EM1-02	-	-	38T-202-00
	EM1-02	EM2-01	38-801-00	-	38T-201-00 38T-211-00

PRESS CORNER JOINTS / PRES KÖŞE BAĞLANTILAR

GASKETS / FİTİLLER

ACCESSORY CODE AKSESUAR KOD	DRAWING ÇİZİM	PROFILE CODE PROFİL KOD	QUANTITY MİKTAR	CUTTING SIZE KESİM ÖLÇÜSÜ	APPLICATION PROFILES ÇALIŞTIĞI PROFİL	APPLICATION DETAIL UYGULAMA DETAY
CC-101-08.2		09-101-00	90 pieces adet	08.2 mm	38T-201-00 38T-211-00 38T-411-00 38T-412-00 38T-413-00	
CC-101-26.3		09-101-00	75 pieces adet	26.3 mm	38T-101-00 38T-112-00 38T-103-00 38T-113-00 38T-122-00 38T-123-00 38T-132-00 38T-133-00 38T-172-00 38T-182-00 38T-143-00 38T-197-00 38T-163-00 38T-173-00 38T-183-00	
CC-103-19.5		09-103-00	42 pieces adet	19.5 mm	60T-108-00	
CC-119-26.3		09-119-00		26.3 mm	38T-182-00 38T-183-00 38T-143-00 38T-197-00	

CODE KOD	DRAWING ÇİZİM	APPLICATION UYGULAMA	DESCRIPTION AÇIKLAMA	WEIGHT kg/m AĞIRLIK	PACKAGE QUANTITY PAKET MİKTARI
EM1-02			GLAZING GASKET INSIDE İÇ CAM FİTİLİ (EPDM)	0.050	300 m
EM1-03			GLAZING GASKET INSIDE İÇ CAM FİTİLİ (EPDM)	0.060	250 m
EM1-04			GLAZING GASKET INSIDE İÇ CAM FİTİLİ (EPDM)	0.070	215 m
EM2-01			GLAZING GASKET OUTSIDE DIŞ CAM FİTİLİ (EPDM)	0.052	285 m
EM45-05			FRAME GASKET KASA FİTİLİ (EPDM)	0.030	500 m
EM38-03			FRAME GASKET KASA FİTİLİ (EPDM)	0.110	136 m
EM38-04			CLAMPING GASKET STANDARD KENET FİTİLİ - STANDART (EPDM)	0.148	101 m
EM38-14			CLAMPING GASKET NARROW KENET FİTİLİ - DAR (EPDM)	0.093	161 m
EM38-05			ADAPTER GASKET ADAPTÖR FİTİLİ (EPDM)	0.210	71 m
EM5-05			BRUSH FİRÇA	-	350 m
EM5-10			BRUSH FİRÇA	-	300 m

ACCESSORIES / AKSESUARLAR

ACCESSORY CODE AKSESUAR KOD	DRAWING ÇİZİM	APPLICATION PROFILES ÇALIŞTIĞI PROFİL	PACKAGE QUANTITY PAKET MİKTARI	APPLICATION DETAIL UYGULAMA DETAY
EM38-91		EMBEDDING HANDLE AND STRIKER HAVUZ KOL VE KARŞILIĞI	SET / TAKIM	
EM38-32		PULLEY WITH 2 WHEELS SÜRME İKİLİ RULMAN (120 Kg)	PIECE / ADET	
MS-20		PULLEY (FOR FLY SCREEN) MAKARA (SİNEKLİK İÇİN)	PIECE / ADET	
EM38-11		PVC PROFILE PVC PROFİL	6 - METERS 6 - METRE	
EM38-51		PVC ESPAGNOLETTE PROFILE PVC İSPANYOLET PROFİLİ	6 - METERS 6 - METRE	
EM38-23		STOPPER STOPER	PIECE / ADET	
EM38-22		SASH STABILITY ADAPTER TİTREŞİM TAKOZU	PIECE / ADET	
EM38-25		WEATHER STRIP HAVA KESİCİ	PIECE / ADET	
EM38-26		FIXED SASH ACCESSORY KANAT SABİTLEME TAKOZU	PIECE / ADET	
EM38-24		COVER CLIP - STANDARD ADAPTÖR KAPAĞI STANDART	SET / TAKIM	
EM38-512		COVER CLIP - NARROW ADAPTÖR KAPAĞI - DAR	SET / TAKIM	
EM38-211		SUPPORT PROFILE CAP TAKVIYE KAPAĞI	SET / TAKIM	
EM38-411		SUPPORT PROFILE CAP TAKVIYE KAPAĞI	SET / TAKIM	

CORNER JOINTS / KÖŞE BAĞLANTILAR

ACCESSORY CODE AKSESUAR KOD	DRAWING ÇİZİM	APPLICATION PROFILES ÇALIŞTIĞI PROFİL	APPLICATION DETAIL UYGULAMA DETAY
LC-1127		38T-101-00 38T-112-00 38T-103-00 38T-113-00 38T-122-00 38T-123-00 38T-132-00 38T-133-00 38T-172-00 38T-182-00 38T-143-00 38T-197-00 38T-163-00 38T-173-00 38T-183-00	
LC-2320		60T-108-00	
LC-174		60T-108-00	
MK-20.1		38T-201-00 07-102-00 07-103-00 38T-172-00 38T-182-00 38T-163-00 38T-173-00 38T-183-00	
LC-107		38T-122-00 38T-123-00 38T-132-00 38T-133-00 38T-172-00 38T-182-00 38T-143-00 38T-197-00 38T-173-00 38T-183-00	
EM38-21		38T-201-00	
ZM-13		1621 FOR FLY SCREEN SİNEKLİK	

ACCESSORIES / AKSESUARLAR

ACCESSORY CODE AKSESUAR KOD	DRAWING ÇİZİM	APPLICATION PROFILES ÇALIŞTIĞI PROFİL	PACKAGE QUANTITY PAKET MİKTARI	APPLICATION DETAIL UYGULAMA DETAY
EM10-01		DRAINAGE CAP TAHLİYE KAPAĞI	PIECE / ADET	
EM10-02				
EM10-03				
EM10-04				
EM10-05				
EM38T-10		DRAINAGE CAP TAHLİYE KAPAĞI	PIECE / ADET	
EM38T-510		FLY SCREEN RAIL CAP SİNEKLİK RAY KAPAĞI	SET / TAKIM	

**38T SYSTEM / SİSTEM
CUTTING SIZE / KESİM ÖLÇÜLERİ**

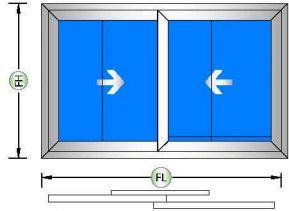

38T SLIDING - STANDARD

38T SÜRME - STANDART

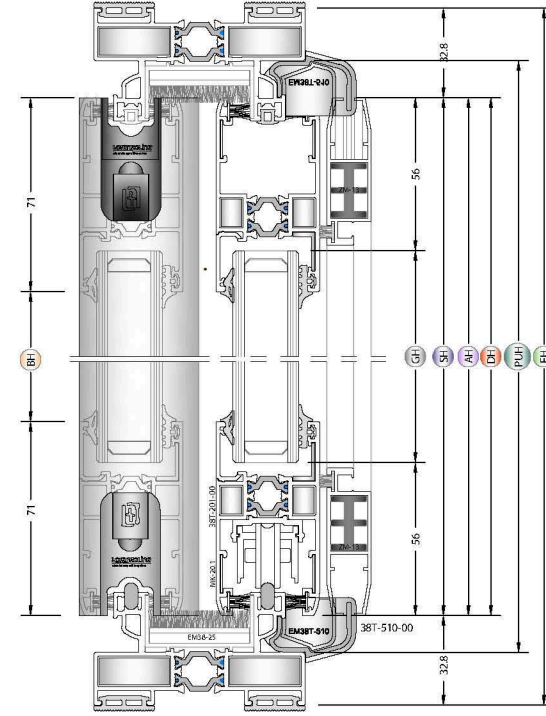
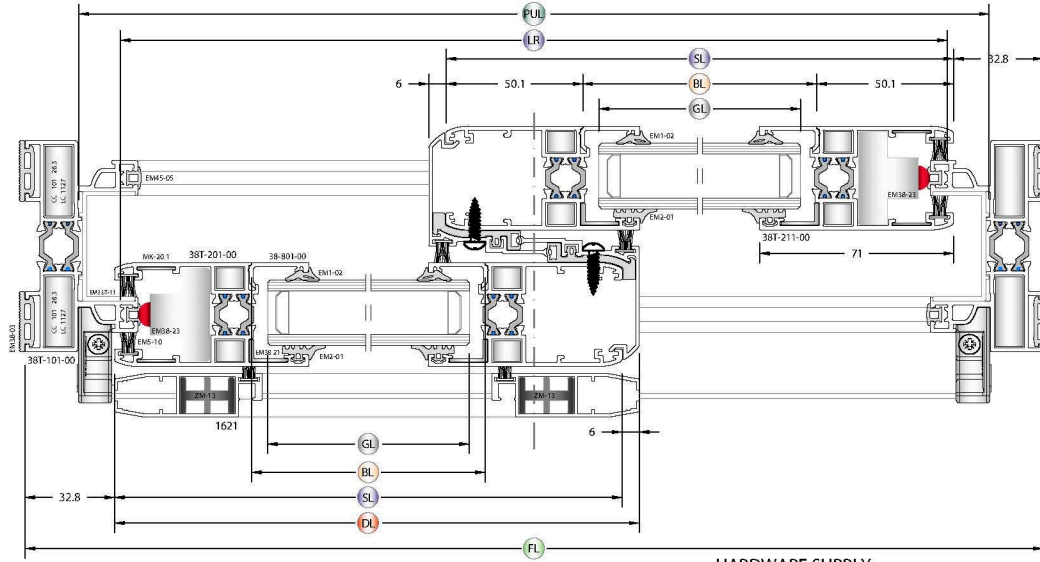

B DETAIL / B DETAYI

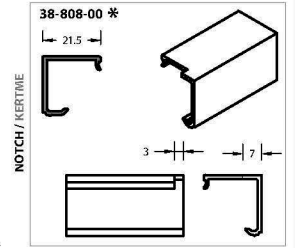

PROFILES / PROFİLLER

Code Kod	Drawing Çizim	Cut Kesim	Quantity (pcs-m) Kesim (Paket)	Dimensions (mm) Boyutlar
38T-101-00			2 pcs/adet	FL
38T-201-00			4 pcs/adet	SL = $\frac{FL-1}{2}$
38-801-00			4 pcs/adet	SH = FH - 65.6
38-802-00			4 pcs/adet	BL = SL - 100
38-808-00			4 pcs/adet	BH = SH - 142
38T-502-00			2 pcs/adet	AH = SH
13-134-050R			2 pcs/adet	LR = FL - 74
EM38-11			2 pcs/adet	PUL = FL - 40
			2 pcs/adet	PUH = FH - 40
1621			2 pcs/adet	DL = SL + 6
			2 pcs/adet	DH = SH
38T-510-00			2 pcs/adet	FL - 45

HARDWARE SUPPLY

SARF MALZEMELER

Code Kod	Quantity (pcs - m) Miktar (Adet-m)	Picture Resim
CC-101-26.3 / LC-1127	8 pcs/adet	
CC-101-08.2	16 pcs/adet	
EM38-21	8 pcs/adet	
MK-20.1	16 pcs/adet	
ZM-13	4 pcs/adet	
EM5-10	{8 x SL} + {6 x SH}	
EM5-05	{2 x DL} + {2 x DH}	
EM45-05	{2 x FL} + {4 x FH}	
EM2-01	{4 x SL} + {4 x SH}	
EM1-0X	{4 x SL} + {4 x SH}	
EM38-04	2 x SH	
EM38-03	{4 x FL} + {4 x FH}	

ACCESSORIES / AKSESUARLAR

Code Kod	Description Açıklama	Quantity Miktar	Picture Resim
EM38-32	Pulley With 2 Wheels Sürme İki kılı Rulman (120 kg)	4 pcs/adet	
EM38-91	Embedding Handle and striker Havuz Kol ve Karşılığı	2 set/takım	
EM38-23	Stopper Stoper	4 pcs/adet	
EM38-22	Sash Stability Adapter Titreşim Takozu	4 pcs/adet	
EM38-24	Cover Clip Adaptör Kapığı	2 set/takım	
EM38-25	Weather strip Hava Kesici	2 pcs/adet	
MS-20	Pulley (For Fly Screen) Makara (Sineklik için)	2 pcs/adet	
EM38T-510	Fly Screen Rail Cap Sineklik Ray Kapığı	2 set/takım	
EM38T-10	Drainage Cap Tahliye Kapığı	2 pcs/adet	

GLASS / CAM

Code Kod	Drawing Çizim	Quantity (pcs-m) Kesim (Paket)	Dimensions (mm) Boyutlar
Glass		2 pcs/adet	GL = SL - 112
Cam		2 pcs/adet	GH = SH - 112

C DETAIL / C DETAYI

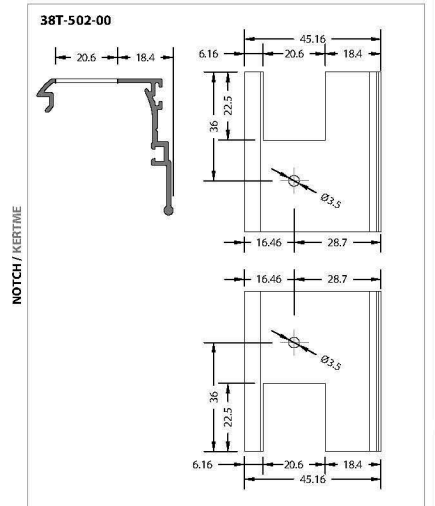

Cutting dimensions for other typologies, please contact with us.

Diğer açılım tipleri kesim ölçüleri için lütfen irtibata geçiniz.

Produced by 

KURTOĞLU BAKIR KURŞUN SAN. A.Ş.
İstasyon Mah. Akbayır Mevkii Kümesi No: 81
Velimeşe - Çorlu 59851 Tekirdağ / TÜRKİYE
T: +90 282 684 70 00 F: +90 282 684 70 01
www.kurtogluas.com kurtoglu@kurtogluas.com

 **Lorenzoline**
aluminium profile system