

EDITION / VERSİYON
03/2012

SLIDING SYSTEM
SÜRME SİSTEMİ

SYSTEM 45T
SİSTEM 45T

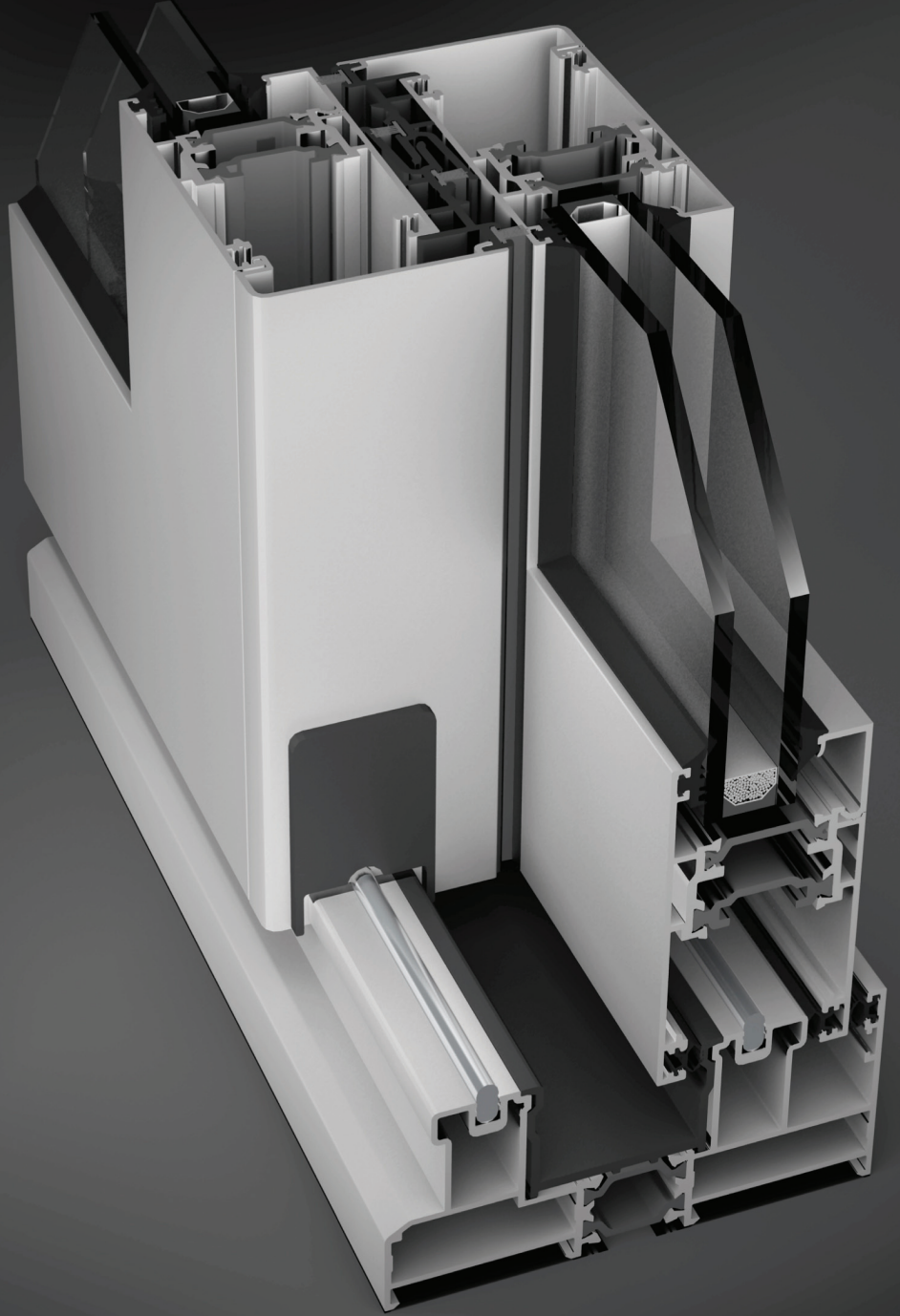

 **Lorenzoline**[®]
aluminium profile system



SLIDING SYSTEM SÜRME SİSTEMİ

SYSTEM 45T SİSTEM 45T



TECHNICAL INFORMATIONS / TEKNİK AÇIKLAMALAR

System Properties / Sistem Özellikleri

One Profile Two Different System / Tek Profil İki Farklı Sistem

- 1- Sliding / Sürme
- 2- Lift & Slide / Kaldır Sür

Wall Thickness / Et Kalınlığı : 1.5 mm

Vent Height / Kanat Genişliği : 45 mm

Isolation Bar / Isı Bariyeri : 32 mm

EPDM Gaskets / EPDM Fitiller

For Sliding - Brush / Sürme İçin Fırça

For Lift & Slide - TPV Gasket / Kaldır Sür İçin TPV Fitil

Glazing From 20 mm to 34 mm

Cam Kullanımı 20 mm'den 34 mm

Thermal Permability / Isı Geçirgenlik : (Uf): 3.90 W/m²K

Sliding Opportunities Sürme Seçenekleri

SLIDING / Sürme

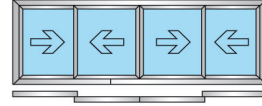
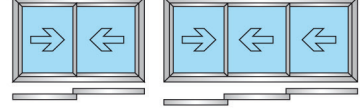

LIFT & SLIDE / Kaldır Sür

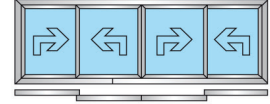
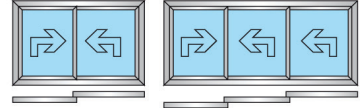

Code Logic / Kod Mantığı

45T 101 00

Factory Standard
Fabrika Standardı

Group / Grup

Title / Seri

Titles / Seriler

45T - System Name / Sistem Adı

09 - Extruded Corner Joints / Pres Köşe Takozu

Groups / Gruplar

101, 102,... - Frames / Kasalar

201, 251,... - Vents / Kanatlar

301, 302,... - Mullions / Orta Kayıtlar

501, 502,... - Adaptors / Adaptörler

801, 802,... - Glazing Beats / Cam Çıtalaları

Alloy / Alaşım

The alloys of the aluminium profiles are 6060 and 6063 (AlMgSi 0,5 - F22) based on EN 12020-2 / 755-9 standards

Alüminyum profil alaşımları 6060 ve 6063 (AlMgSi 0,5 - F22) EN 12020-2 / 755-9 standartlarına uygundur.

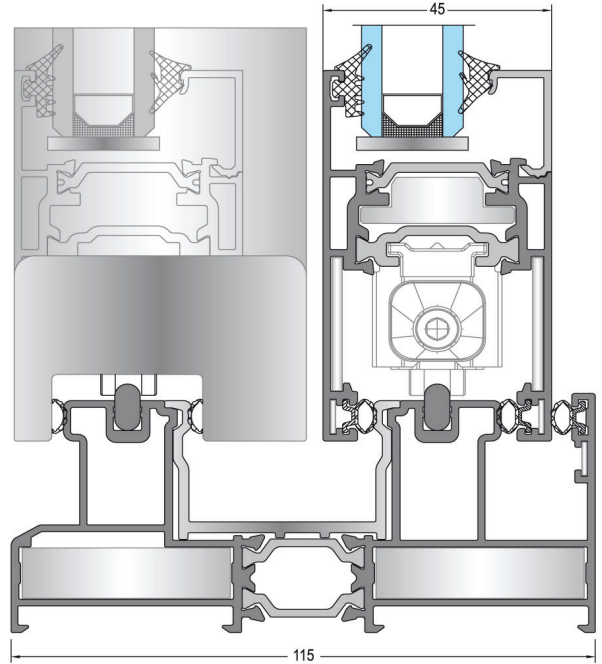

Sliding / Sürme



EM45-02

Brush / Sürme

Lift & Slide / Kaldır Sür



EM45-02

TPV Gasket / Kaldır Sür

All drawings are not scaled.
Tüm çizimler ölçeksizdir.

Lorenzoline
aluminium profile system



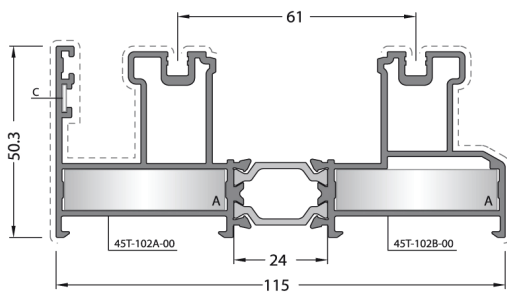

CODE / KOD
45T-102-00

THEORETICAL WEIGHT kg/m
TEORİK AĞIRLIK kg/m
2.317

EXTRUDED CORNER JOINT
KÖŞE TAKOZU

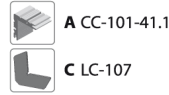

DIE-CAST CORNER JOINT
DÖKÜM BAĞLANTI

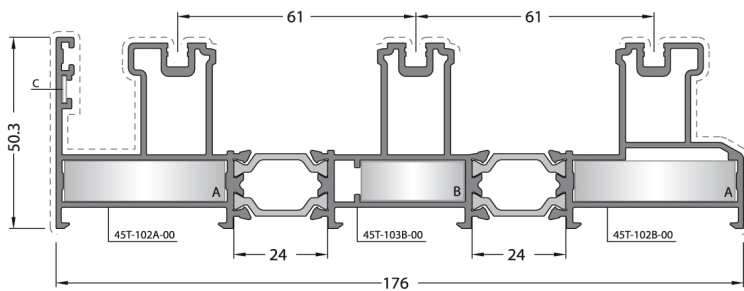

CODE / KOD
45T-103-00

THEORETICAL WEIGHT kg/m
TEORİK AĞIRLIK kg/m
3.507

EXTRUDED CORNER JOINT
KÖŞE TAKOZU

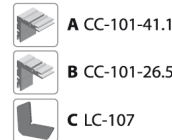

DIE-CAST CORNER JOINT
DÖKÜM BAĞLANTI

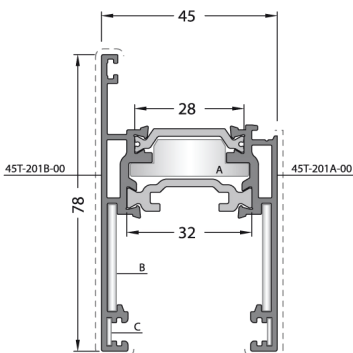

CODE / KOD
45T-201-00

THEORETICAL WEIGHT kg/m
TEORİK AĞIRLIK kg/m
1.472

CORNER JOINT
KÖŞE TAKOZU

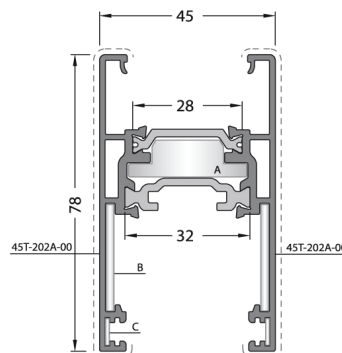

CODE / KOD
45T-202-00

THEORETICAL WEIGHT kg/m
TEORİK AĞIRLIK kg/m
1.591

CORNER JOINT
KÖŞE TAKOZU

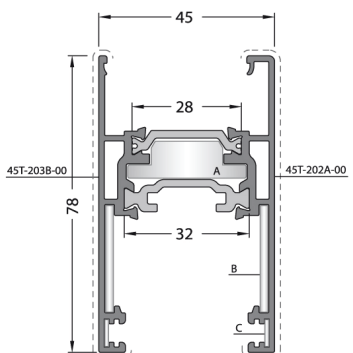

CODE / KOD
45T-203-00

THEORETICAL WEIGHT kg/m
TEORİK AĞIRLIK kg/m
1.562

CORNER JOINT
KÖŞE TAKOZU

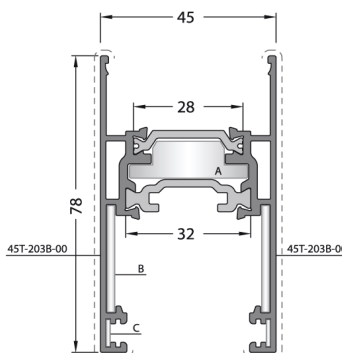
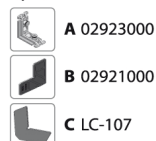

CODE / KOD
45T-204-00

THEORETICAL WEIGHT kg/m
TEORİK AĞIRLIK kg/m
1.533

CORNER JOINT
KÖŞE TAKOZU

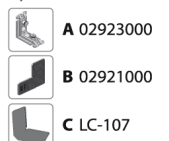

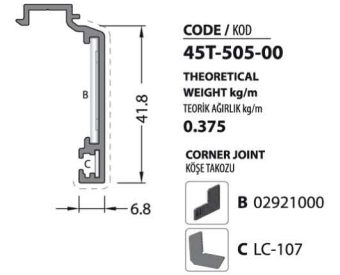
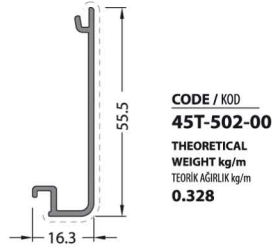
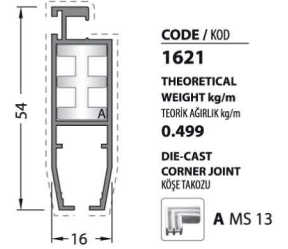
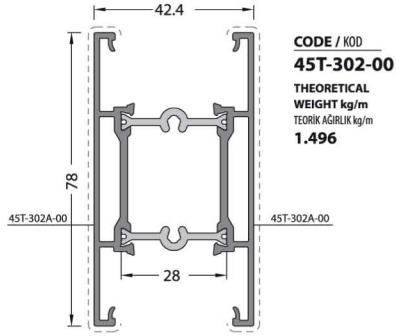
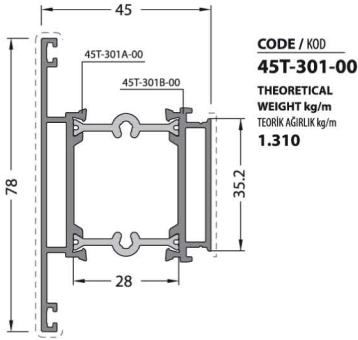

No visible surface
Görünen yüzeyi yoktur

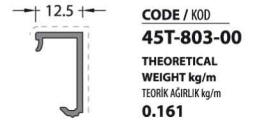
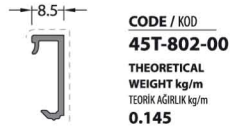
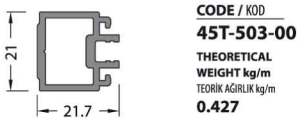

20 Micron Anodized.
20 Mikron Eloksal.

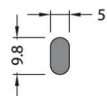

No visible surface
Görünen yüzeyi yoktur

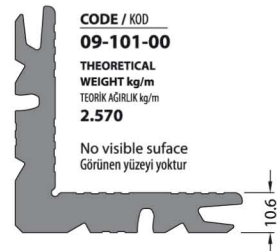
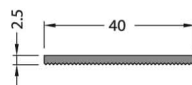

GASKETS / FİTİLLER

CODE KOD	DRAWING ÇİZİM	APPLICATION UYGULAMA	DESCRIPTION AÇIKLAMA	WEIGHT kg/m AĞIRLIK kg/m	IN ONE PACKAGE PAKET MİKTARI
EM1-02			Glazing Gasket Inside (EPDM) İç Cam Fıtılı	0.050	300 m
EM1-03			Glazing Gasket Inside (EPDM) İç Cam Fıtılı	0.060	250 m
EM1-04			Glazing Gasket Inside (EPDM) İç Cam Fıtılı	0.070	215 m
EM2-01			Glazing Gasket Outside (EPDM) Dış Cam Fıtılı	0.055	270 m
EM45-02			Brush Fırça	-	225 m
EM45-03			TPV Gasget TPV Fıtıl	0.019	300 m
EM45-05			Frame Gasget Kasa Fıtılı	0.030	500 m

GASKETS / FİTİLLER

CODE KOD	DRAWING ÇİZİM	PACKAGE CODE PAKET KODU	QUANTITY MİKTAR	CUTTING SIZE KESİM ÖLÇÜSÜ	APPLICATION PROFILES UYGULAMA PROFİLLERİ	APPLICATION DETAILS UYGULAMA DETAYI
09-101-00		CC-101-41.1	45 pieces parça	41.1 mm	45T-102-00 45T-103-00	
09-101-00		CC-101-26.5	75 pieces parça	26.5 mm	45T-103-00	

CODE KOD	DRAWING ÇİZİM	APPLICATION PROFILES UYGULAMA PROFİLLERİ	APPLICATION DETAILS UYGULAMA DETAYI
LC-1141		45T-102-00 45T-103-00	
LC-1127		45T-103-00	
LC-107		45T-102-00 45T-103-00 45T-201-00 45T-202-00 45T-203-00 45T-204-00	
02923000		45T-201-00 45T-202-00 45T-203-00 45T-204-00	
02921000		45T-201-00 45T-202-00 45T-203-00 45T-204-00	
MS 13		1621	

GLAZING COMBINATION / CAM KOMBİNASYONLARI









GLAZING THICKNESS ÇİZİM	GLAZING GASKET INSIDE İÇ CAM FİTİLİ	GLAZING GASKET OUTSIDE DIŞ CAM FİTİLİ	GLAZING BEAD CAM ÇİTASI
20 mm	EM1-04	EM1-04	45T-202-00
22 mm	EM1-03	EM1-03	45T-202-00
24 mm	EM1-02	EM1-02	45T-202-00
26 mm	EM1-03	EM1-04	45T-203-00
28 mm	EM1-02	EM1-03	45T-203-00
28 mm	EM1-04	EM1-04	45T-204-00
30 mm	EM1-03	EM1-03	45T-204-00
32 mm	EM1-02	EM1-02	45T-204-00



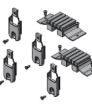

WITH GLAZING BEAT / CAM ÇİTALI

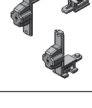

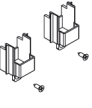

GLAZING THICKNESS ÇİZİM	GLAZING GASKET INSIDE İÇ CAM FİTİLİ	GLAZING GASKET OUTSIDE DIŞ CAM FİTİLİ	GLAZING BEAD CAM ÇİTASI
20 mm	EM1-04	EM2-01	45T-803-00
22 mm	EM1-02	EM2-01	45T-803-00
24 mm	EM1-04	EM2-01	45T-802-00
26 mm	EM1-02	EM2-01	45T-802-00

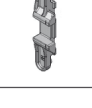
ACCESSORY CODE AKSESUAR KODU	DRAWING ÇİZİM	DESCRIPTION AÇIKLAMA	APPLICATION DETAIL UYGULAMA DETAYI
EM15-200		Polyamid Rod Profile (Euro Section 1) Polyamid Tıj Profili (Avrupa Kanal 1)	

ACCESSORY CODE AKSESUAR KODU	DRAWING ÇİZİM	PROFILES PROFİLLER	APPLICATION DETAIL UYGULAMA DETAYI
EM45-11		PVC Profile PVC Profil	
EM45-12		Polyamid	
EM45-14		PVC Profile PVC Profil	
EM10-01 (White / Beyaz)		Drainage Cap Tahliye Kapağı	
EM10-02 (Black / Siyah)			
EM10-03 (Brown / Kahverengi)			
EM10-04 (Gray / Gri)			

CODE KOD	DESCRIPTION AÇIKLAMA	PICTURE RESİM	SLIDE SÜRME		LIFT & SLIDE KALDIR SÜR	
			100 kg	200 kg	90 kg	200 kg
02910000	Pulley With Wheel Sürme Tekli Rulman		x			
02911000	Pulley With 2 Wheels Sürme İkili Rulman			x		
02912000	Kit Pulleys L & S 1 Wheel + Mechanism Kaldır Sür Tekli Rulman Takımı				x	
02913000	Kit Pulleys L & S 2 Wheels + Mechanism Kaldır Sür İkili Rulman Takımı					x
02931000	Locking Kit Dil ve Karşılık		x	x	x	x
02935000	Central Plugs Kit For Sliding Sürme Kapak ve Hava Kesici Takımı		x	x		
02943000	Central Plugs Kit For L&S Kaldır Sür Kapak ve Hava Kesici Takımı				x	x
02933000	Shock Absorber And Lift Proof Plugs Kit For Sliding Sürme Stoper		x	x		
02939000	Shock Absorber And Lift Proof Plugs Kit For L&S Kaldır Sür Stoper				x	x

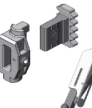
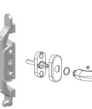
CODE KOD	DESCRIPTION AÇIKLAMA	PICTURE RESİM
02947000	Cap For 4 Sash 4 Kanat Adaptör Kapağı	
02954000	Fixed Sash Kit Sabit Kanat Mesafe Takoğu	
02940000	Cremone Driving Rod Maçalı Kol İletişim Ekipmanı	
MS 20	Fly Screen Pulley Sineklik Rulmanı	

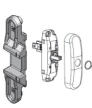
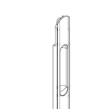
CODE KOD	DESCRIPTION AÇIKLAMA	PICTURE RESİM	SLIDE SÜRME		LIFT & SLIDE KALDIR SÜR	
			100 kg	200 kg	90 kg	200 kg
EM45-91	Embedding Handle Havuz Kol ve İletişim Ekipmanı		x	x		
EM45-92	Embedding Handle With Lock Kilitli Havuz Kol ve İletişim Ekipmanı		x	x		
EM45-93	Embedding Lever Handle Kaldır Sür İçin Havuz Kol ve İletişim Ekipmanı					x
EM45-94	Handle Kare Millli Kol ve İletişim Ekipmanı		x	x	x	x
EM45-95	Handle With Lock Kare Millli Kol ve İletişim Ekipmanı + Kilit		x	x	x	x
EM45-96	Cremone Maçalı Kol ve İletişim Ekipmanı		x	x		
02980000	Pulling Handle Çekme Kol		x	x		

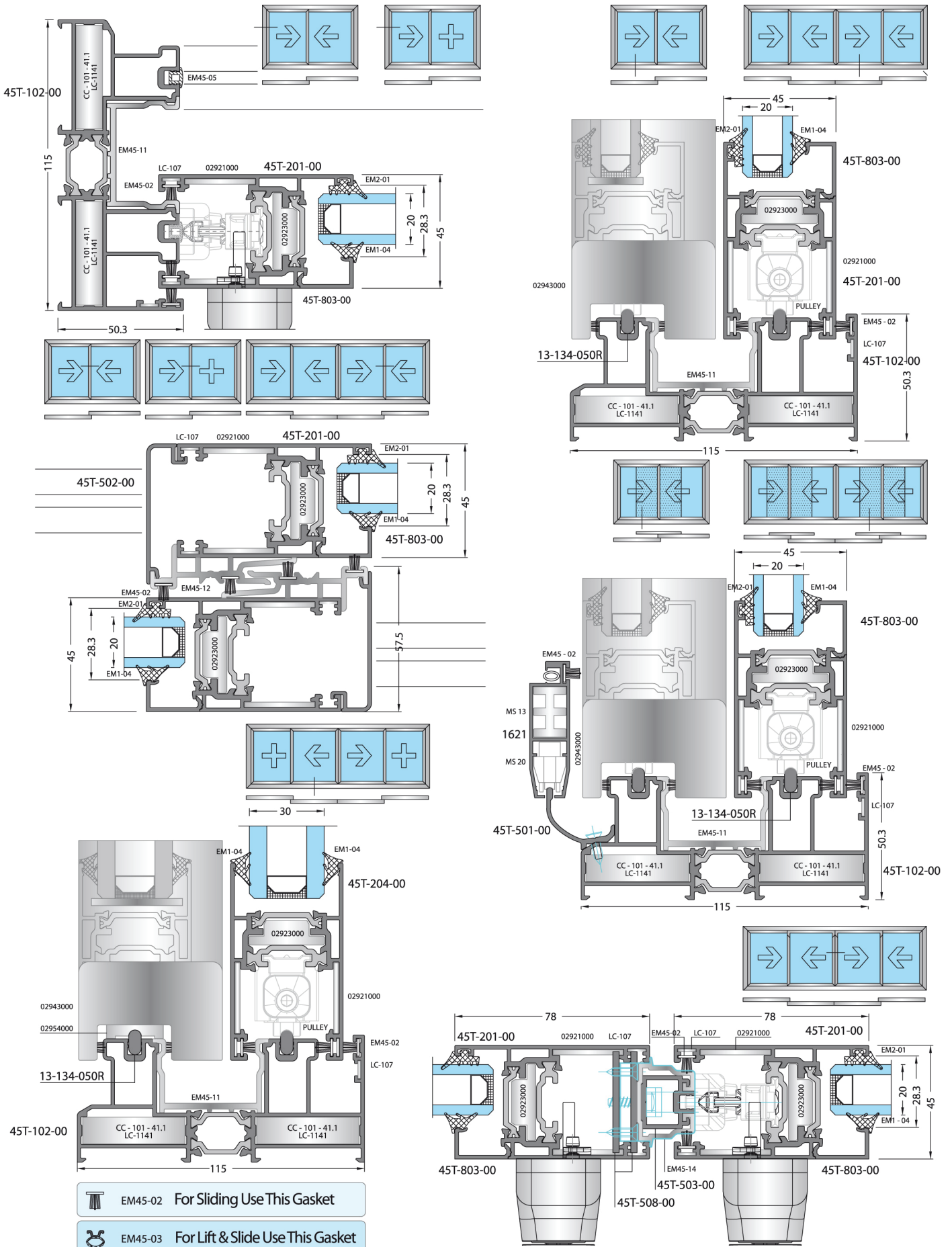



Produced by 

KURTOĞLU BAKIR KURŞUN SAN. A.Ş.

İstasyon Mah. Akbayır Mevkii Kümesi No: 81
Velimeşe - Çorlu 59851 Tekirdağ / TÜRKİYE
T: +90 282 684 70 00 F: +90 282 684 70 01
www.kurtogluas.com kurtoglu@kurtogluas.com

 **Lorenzoline**[®]
aluminium profile system