

EDITION / VERSİYON  
04 / 2011



**FURNITURE** PROFILES

**MOBİLYA** PROFİLLERİ

 **Lorenzoline**<sup>®</sup>  
aluminium profile system

# HARMONY OF SAFETY AESTHETICS

The best way to draw reliable and  
aesthetic border without losing your freedom...

## INDEX / İÇİNDEKİLER

<b>Furniture Profiles / Mobilya Profilleri</b>	04-22
<b>Standard Profiles / Standart Profiller</b>	24-30
<b>Carpet-Stairs and Tile Profiles / Halı-Merdiven ve Fayans Profilleri</b>	32-37



**mobilyaprofilleri**

**furnitureprofiles**

frame cover profiles / çerçeve kapak profilleri

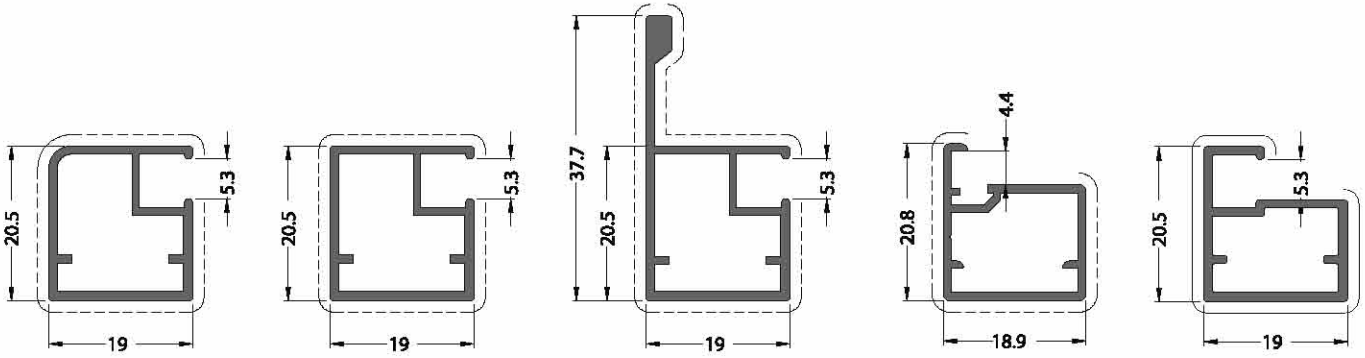

**CODE / KOD**  
**21-230-00**  
**THEORETICAL WEIGHT**kg/m  
*TEORİK AĞIRLIK kg/m*  
**0.263**

**CODE / KOD**  
**21-223-00**  
**THEORETICAL WEIGHT**kg/m  
*TEORİK AĞIRLIK kg/m*  
**0.266**

**CODE / KOD**  
**21-224-00**  
**THEORETICAL WEIGHT**kg/m  
*TEORİK AĞIRLIK kg/m*  
**0.351**

**CODE / KOD**  
**21-161-00**  
**THEORETICAL WEIGHT**kg/m  
*TEORİK AĞIRLIK kg/m*  
**0.231**

**CODE / KOD**  
**21-233-011**  
**THEORETICAL WEIGHT**kg/m  
*TEORİK AĞIRLIK kg/m*  
**0.250**

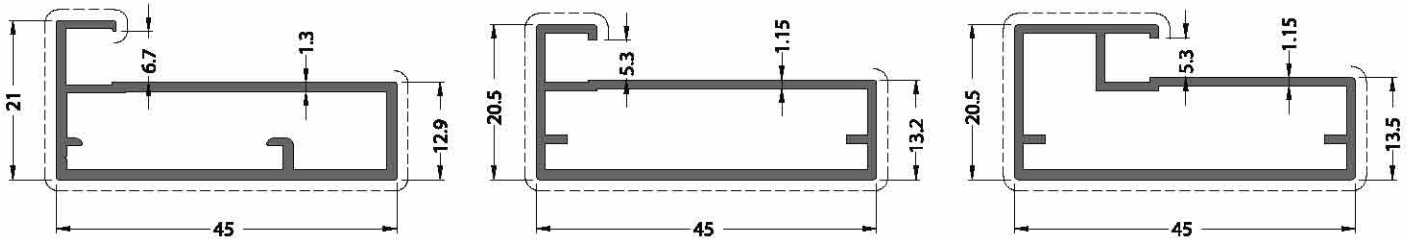

**CODE / KOD**  
**21-162-00**  
**THEORETICAL WEIGHT**kg/m  
*TEORİK AĞIRLIK kg/m*  
**0.471**

**CODE / KOD**  
**21-227-00**  
**THEORETICAL WEIGHT**kg/m  
*TEORİK AĞIRLIK kg/m*  
**0.430**

**CODE / KOD**  
**21-226-00**  
**THEORETICAL WEIGHT**kg/m  
*TEORİK AĞIRLIK kg/m*  
**0.456**

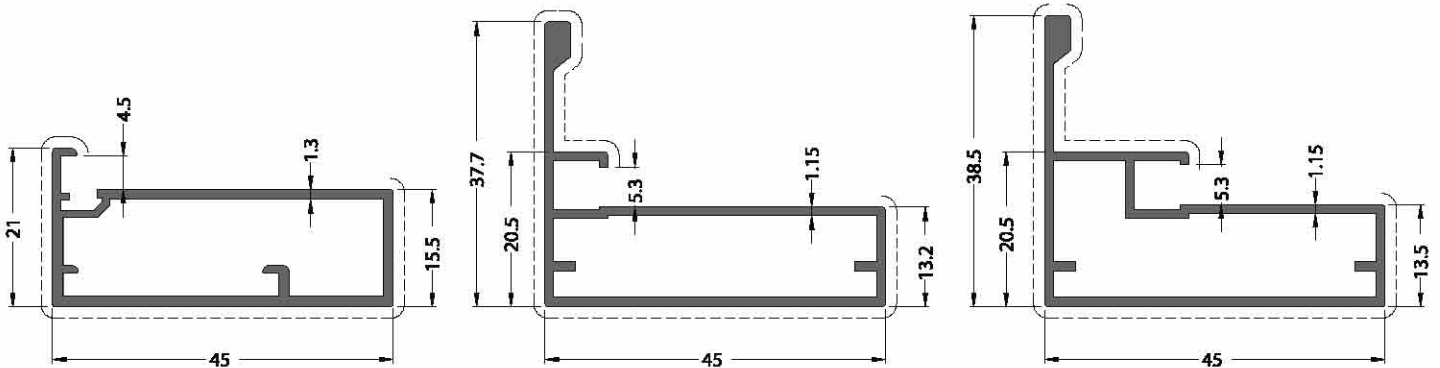

**CODE / KOD**  
**21-186-013**  
**THEORETICAL WEIGHT**kg/m  
*TEORİK AĞIRLIK kg/m*  
**0.472**

**CODE / KOD**  
**21-225-00**  
**THEORETICAL WEIGHT**kg/m  
*TEORİK AĞIRLIK kg/m*  
**0.518**

**CODE / KOD**  
**21-228-00**  
**THEORETICAL WEIGHT**kg/m  
*TEORİK AĞIRLIK kg/m*  
**0.546**

door-drawerhandleprofiles / kapak-çekmeboykulpları

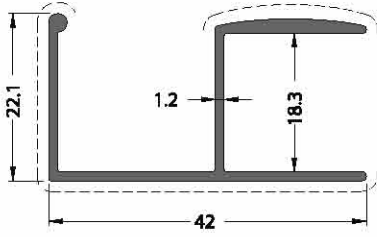

**CODE / KOD**  
**21-104-00** **THEORETICAL**  
**WEIGHTkg/m**  
*TEORİK AĞIRLIK kg/m*  
**0.354**

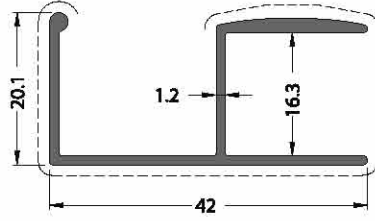

**CODE / KOD**  
**21-187-00** **THEORETICAL**  
**WEIGHTkg/m**  
*TEORİK AĞIRLIK kg/m*  
**0.341**

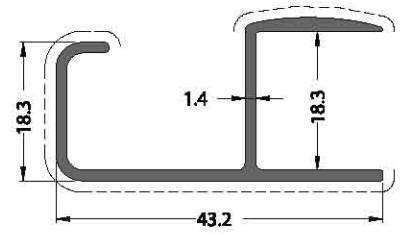

**CODE / KOD**  
**21-189-00** **THEORETICAL**  
**WEIGHTkg/m**  
*TEORİK AĞIRLIK kg/m*  
**0.383**

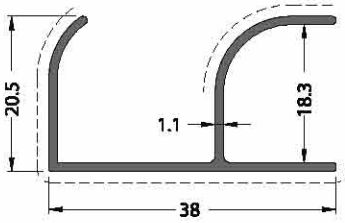

**CODE / KOD**  
**21-105-011** **THEORETICAL**  
**WEIGHTkg/m**  
*TEORİK AĞIRLIK kg/m*  
**0.265**

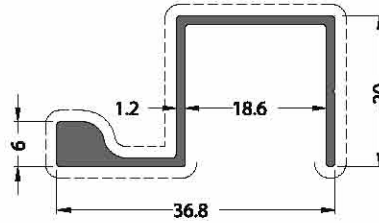

**CODE / KOD**  
**21-207-012** **THEORETICAL**  
**WEIGHTkg/m**  
*TEORİK AĞIRLIK kg/m*  
**0.322**

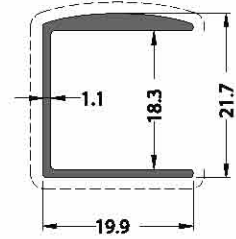

**CODE / KOD**  
**21-103-00** **THEORETICAL**  
**WEIGHTkg/m**  
*TEORİK AĞIRLIK kg/m*  
**0.212**

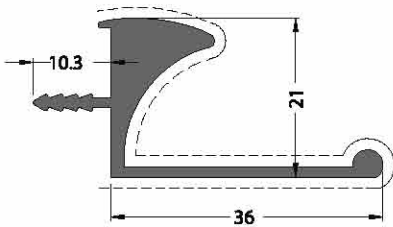

**CODE / KOD**  
**21-197-013** **THEORETICAL**  
**WEIGHTkg/m**  
*TEORİK AĞIRLIK kg/m*  
**0.505**

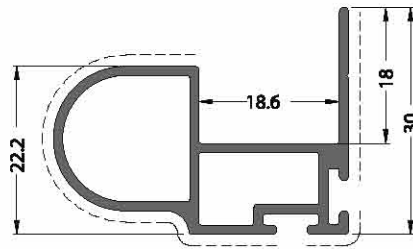

**CODE / KOD**  
**21-221-012** **THEORETICAL**  
**WEIGHTkg/m**  
*TEORİK AĞIRLIK kg/m*  
**0.488**

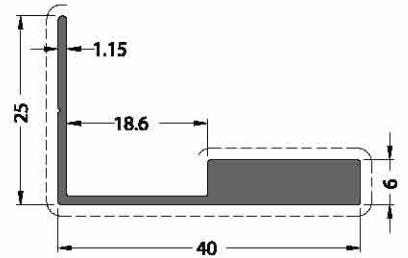

**CODE / KOD**  
**21-208-011** **THEORETICAL**  
**WEIGHTkg/m**  
*TEORİK AĞIRLIK kg/m*  
**0.464**

door-drawer handle profiles / kapak-çekme boykulpları

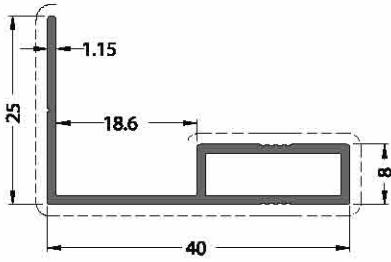

**CODE / KOD**  
**21-229-011** **THEORETICAL**  
**WEIGHTkg/m**  
*TEORİK AĞIRLIK kg/m*  
**0.293**

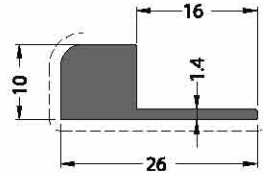

**CODE / KOD**  
**21-179-00** **THEORETICAL**  
**WEIGHTkg/m**  
*TEORİK AĞIRLIK kg/m*  
**0.326**

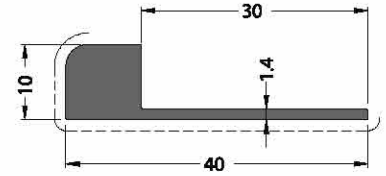

**CODE / KOD**  
**21-174-00** **THEORETICAL**  
**WEIGHTkg/m**  
*TEORİK AĞIRLIK kg/m*  
**0.379**

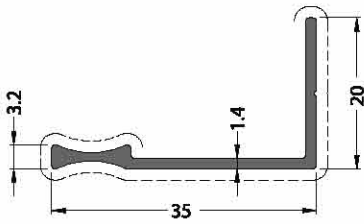

**CODE / KOD**  
**21-232-014** **THEORETICAL**  
**WEIGHTkg/m**  
*TEORİK AĞIRLIK kg/m*  
**0.218**

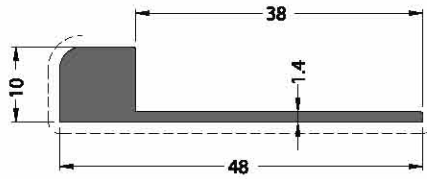

**CODE / KOD**  
**21-180-00** **THEORETICAL**  
**WEIGHTkg/m**  
*TEORİK AĞIRLIK kg/m*  
**0.410**

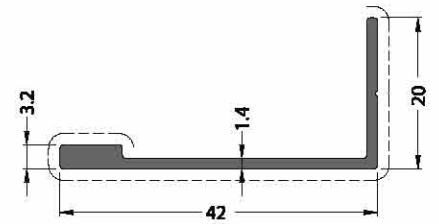

**CODE / KOD**  
**21-231-014** **THEORETICAL**  
**WEIGHTkg/m**  
*TEORİK AĞIRLIK kg/m*  
**0.269**

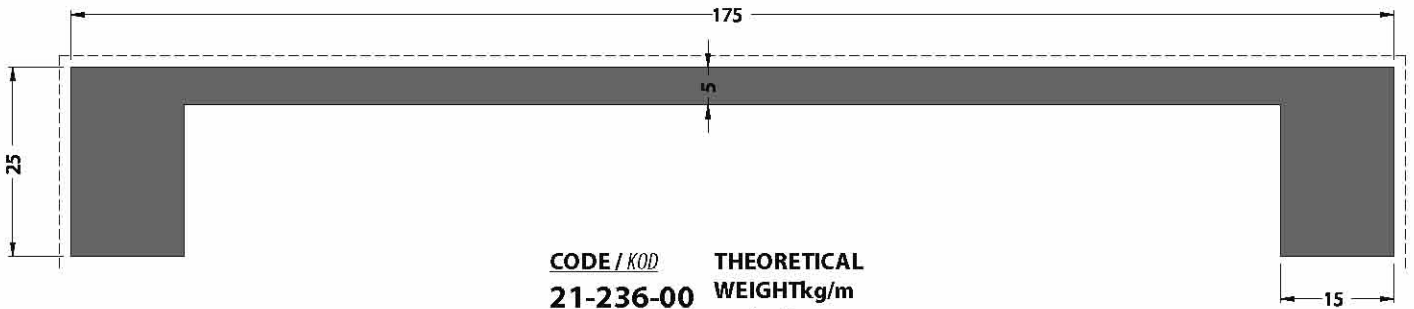

**CODE / KOD**  
**21-236-00** **THEORETICAL**  
**WEIGHTkg/m**  
*TEORİK AĞIRLIK kg/m*  
**3.997**

*sliding cover profiles / sürme kapak profilleri*

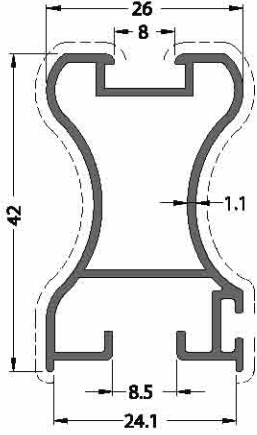

**CODE / KOD**  
**21-125-011**  
**THEORETICAL WEIGHT**kg/m  
*TEORİK AĞIRLIK* kg/m  
**0.498**

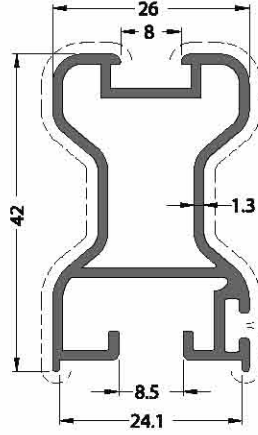

**CODE / KOD**  
**21-126-013**  
**THEORETICAL WEIGHT**kg/m  
*TEORİK AĞIRLIK* kg/m  
**0.603**

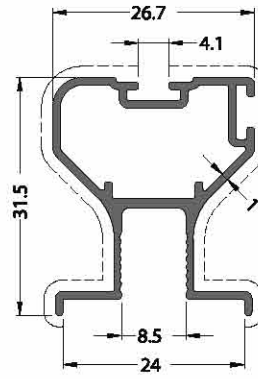

**CODE / KOD**  
**21-218-010**  
**THEORETICAL WEIGHT**kg/m  
*TEORİK AĞIRLIK* kg/m  
**0.377**

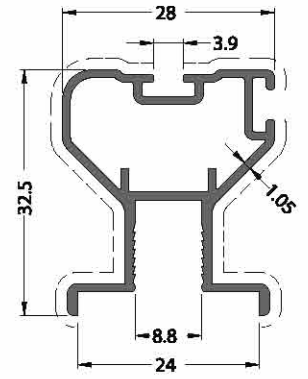

**CODE / KOD**  
**21-144-010**  
**THEORETICAL WEIGHT**kg/m  
*TEORİK AĞIRLIK* kg/m  
**0.427**

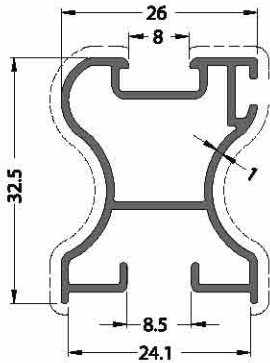

**CODE / KOD**  
**21-190-010**  
**THEORETICAL WEIGHT**kg/m  
*TEORİK AĞIRLIK* kg/m  
**0.391**

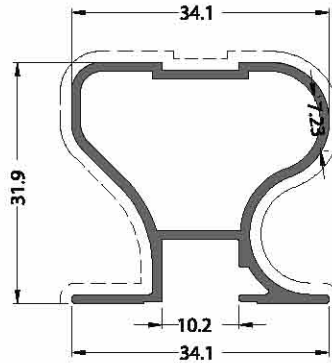

**CODE / KOD**  
**21-158-012**  
**THEORETICAL WEIGHT**kg/m  
*TEORİK AĞIRLIK* kg/m  
**0.446**

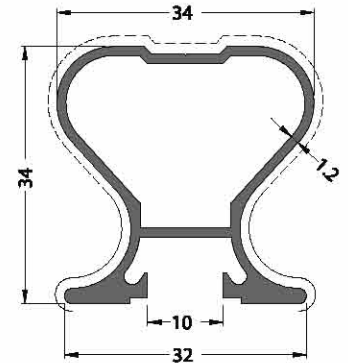

**CODE / KOD**  
**21-185-012**  
**THEORETICAL WEIGHT**kg/m  
*TEORİK AĞIRLIK* kg/m  
**0.513**



sliding cover profiles / sürme kapak profilleri

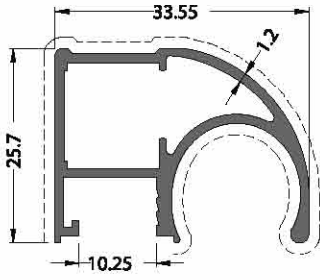

**CODE / KOD**  
**21-152-00**  
**THEORETICAL WEIGHT**kg/m  
*TEORİK AĞIRLIK* kg/m  
**0.437**

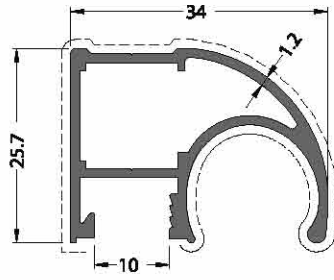

**CODE / KOD**  
**21-164-012**  
**THEORETICAL WEIGHT**kg/m  
*TEORİK AĞIRLIK* kg/m  
**0.450**

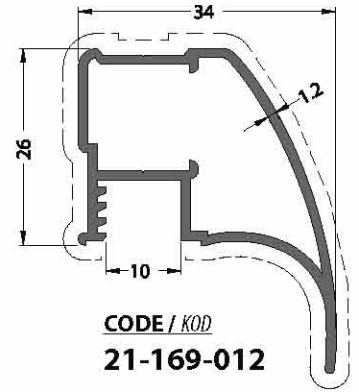

**CODE / KOD**  
**21-169-012**  
**THEORETICAL WEIGHT**kg/m  
*TEORİK AĞIRLIK* kg/m  
**0.457**

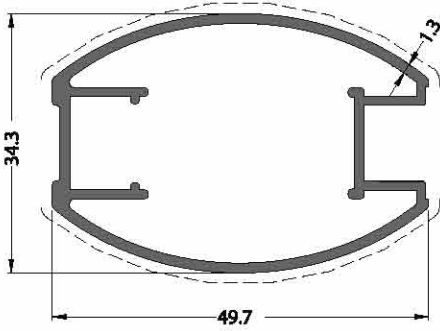

**CODE / KOD**  
**21-159-013**  
**THEORETICAL WEIGHT**kg/m  
*TEORİK AĞIRLIK* kg/m  
**0.632**

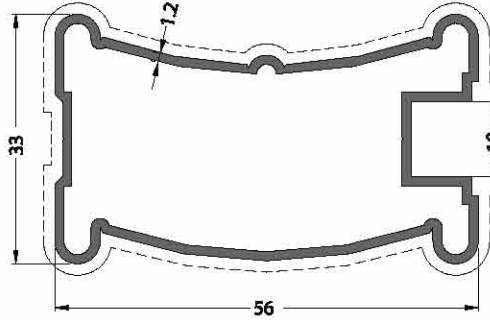

**CODE / KOD**  
**21-166-012**  
**THEORETICAL WEIGHT**kg/m  
*TEORİK AĞIRLIK* kg/m  
**0.659**

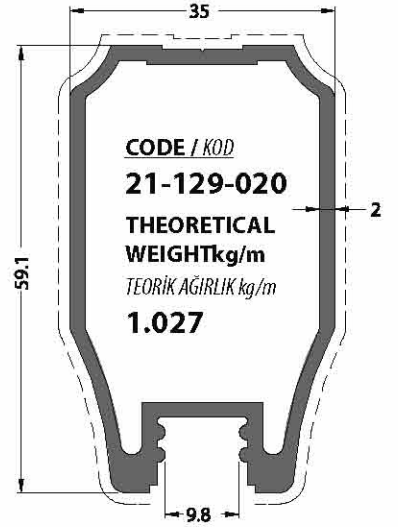

**CODE / KOD**  
**21-129-020**  
**THEORETICAL WEIGHT**kg/m  
*TEORİK AĞIRLIK* kg/m  
**1.027**

decifix frames system profiles  
decifix uygulamalı kapak profilleri

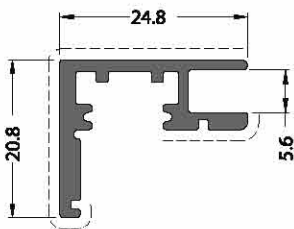

**CODE / KOD**  
**21-106-00**  
**THEORETICAL WEIGHT**kg/m  
*TEORİK AĞIRLIK* kg/m  
**0.331**

decifix frames system profiles  
decifix uygulamalı kapak profilleri

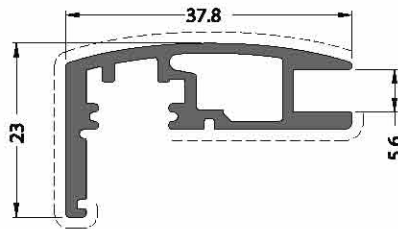

**CODE / KOD**  
**21-107-00**  
**THEORETICAL WEIGHT**kg/m  
*TEORİK AĞIRLIK* kg/m  
**0.500**

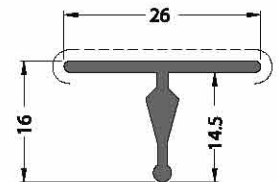

**CODE / KOD**  
**21-160-00**  
**THEORETICAL WEIGHT**kg/m  
*TEORİK AĞIRLIK* kg/m  
**0.191**

sliding cover profiles / sürme kapak profilleri

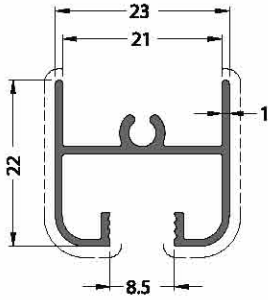

**CODE / KOD**      **THEORETICAL**  
**21-209-00**      **WEIGHTkg/m**  
TEORİK AĞIRLIK kg/m  
**0.244**

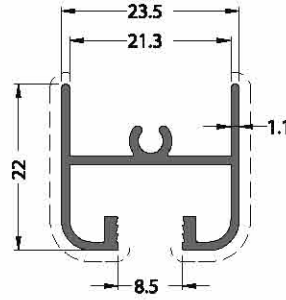

**CODE / KOD**      **THEORETICAL**  
**21-142-011**      **WEIGHTkg/m**  
TEORİK AĞIRLIK kg/m  
**0.282**

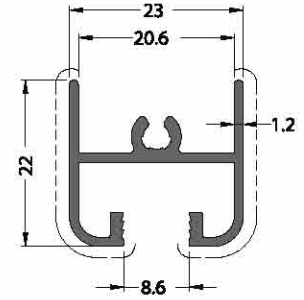

**CODE / KOD**      **THEORETICAL**  
**21-122-012**      **WEIGHTkg/m**  
TEORİK AĞIRLIK kg/m  
**0.312**

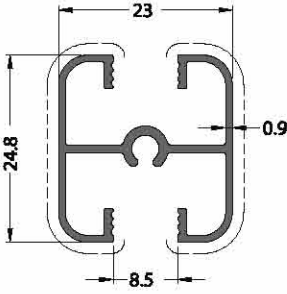

**CODE / KOD**      **THEORETICAL**  
**21-210-00**      **WEIGHTkg/m**  
TEORİK AĞIRLIK kg/m  
**0.291**

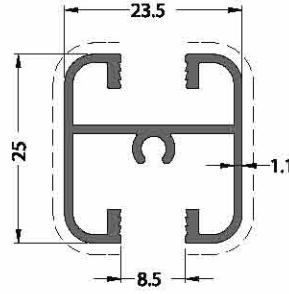

**CODE / KOD**      **THEORETICAL**  
**21-145-011**      **WEIGHTkg/m**  
TEORİK AĞIRLIK kg/m  
**0.360**

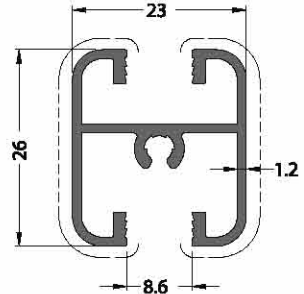

**CODE / KOD**      **THEORETICAL**  
**21-123-012**      **WEIGHTkg/m**  
TEORİK AĞIRLIK kg/m  
**0.396**

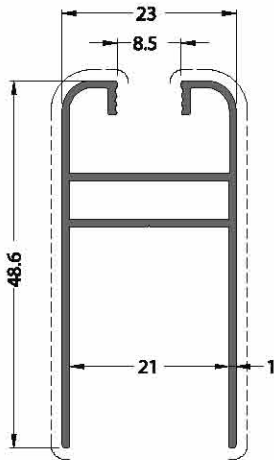

**CODE / KOD**      **THEORETICAL**  
**21-217-00**      **WEIGHTkg/m**  
TEORİK AĞIRLIK kg/m  
**0.414**

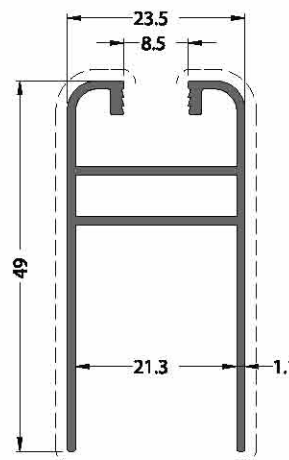

**CODE / KOD**      **THEORETICAL**  
**21-141-011**      **WEIGHTkg/m**  
TEORİK AĞIRLIK kg/m  
**0.478**

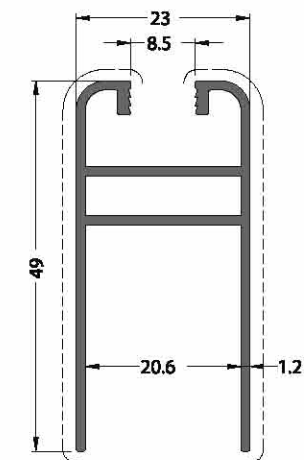

**CODE / KOD**      **THEORETICAL**  
**21-121-012**      **WEIGHTkg/m**  
TEORİK AĞIRLIK kg/m  
**0.511**

sliding cover profiles / sürme kapak profilleri

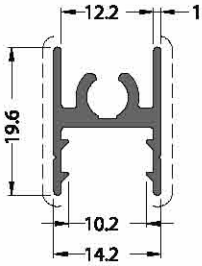

**CODE / KOD**

**21-156-00**

**THEORETICAL WEIGHTkg/m**

*TEORİK AĞIRLIK kg/m*

**0.222**

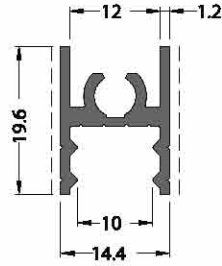

**CODE / KOD**

**21-168-00**

**THEORETICAL WEIGHTkg/m**

*TEORİK AĞIRLIK kg/m*

**0.246**

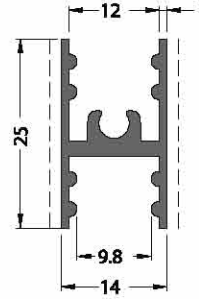

**CODE / KOD**

**21-127-00**

**THEORETICAL WEIGHTkg/m**

*TEORİK AĞIRLIK kg/m*

**0.275**

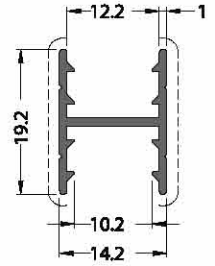

**CODE / KOD**

**21-155-00**

**THEORETICAL WEIGHTkg/m**

*TEORİK AĞIRLIK kg/m*

**0.158**

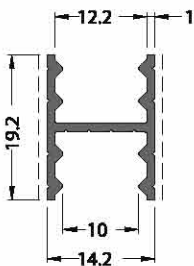

**CODE / KOD**

**21-171-00**

**THEORETICAL WEIGHTkg/m**

*TEORİK AĞIRLIK kg/m*

**0.171**

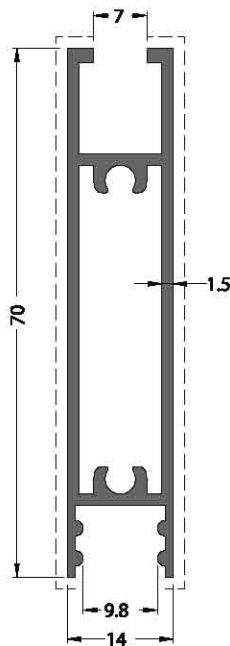

**CODE / KOD**

**21-128-015**

**THEORETICAL WEIGHTkg/m**

*TEORİK AĞIRLIK kg/m*

**0.742**

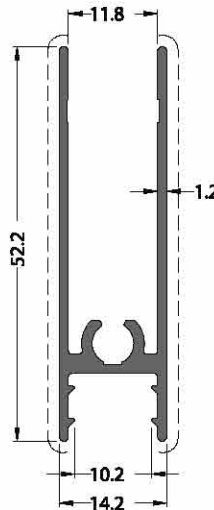

**CODE / KOD**

**21-157-00**

**THEORETICAL WEIGHTkg/m**

*TEORİK AĞIRLIK kg/m*

**0.447**

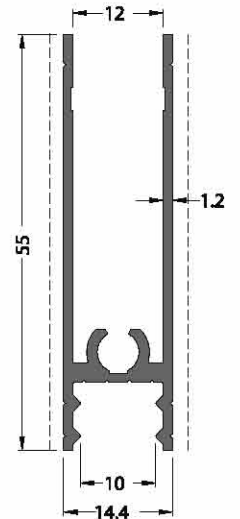

**CODE / KOD**

**21-167-00**

**THEORETICAL WEIGHTkg/m**

*TEORİK AĞIRLIK kg/m*

**0.472**

ray profiles / ray profilleri

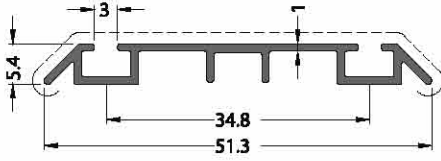

**CODE / KOD**  
**21-182-010**

**THEORETICAL WEIGHT**kg/m  
*TEORİK AĞIRLIK kg/m*  
**0.237**

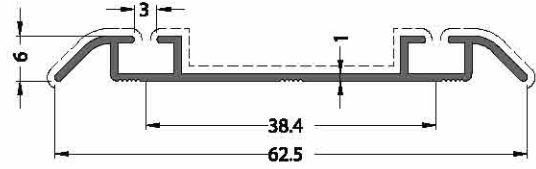

**CODE / KOD**  
**21-165-010**

**THEORETICAL WEIGHT**kg/m  
*TEORİK AĞIRLIK kg/m*  
**0.251**

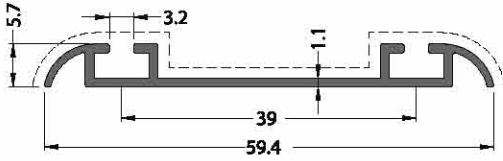

**CODE / KOD**  
**21-153-00**

**THEORETICAL WEIGHT**kg/m  
*TEORİK AĞIRLIK kg/m*  
**0.266**

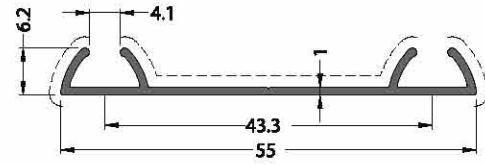

**CODE / KOD**  
**21-206-010**

**THEORETICAL WEIGHT**kg/m  
*TEORİK AĞIRLIK kg/m*  
**0.214**

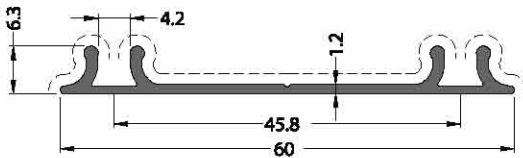

**CODE / KOD**  
**21-114-00**

**THEORETICAL WEIGHT**kg/m  
*TEORİK AĞIRLIK kg/m*  
**0.279**

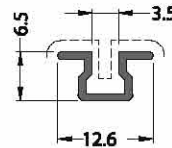

**CODE / KOD**  
**21-200-010**

**THEORETICAL WEIGHT**kg/m  
*TEORİK AĞIRLIK kg/m*  
**0.067**

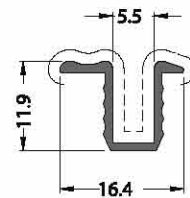

**CODE / KOD**  
**21-202-010**

**THEORETICAL WEIGHT**kg/m  
*TEORİK AĞIRLIK kg/m*  
**0.110**

*rayprofiles / rayprofilleri*

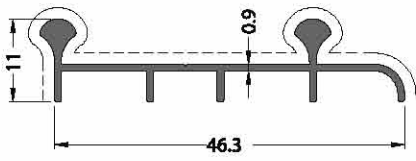

**CODE / KOD**  
**21-211-009** **THEORETICAL WEIGHTkg/m**  
*TEORİK AĞIRLIK kg/m*  
**0.242**

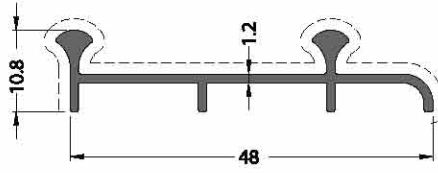

**CODE / KOD**  
**21-124-00** **THEORETICAL WEIGHTkg/m**  
*TEORİK AĞIRLIK kg/m*  
**0.274**

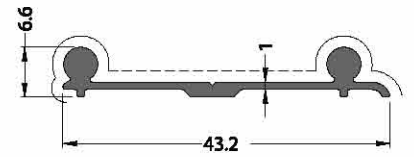

**CODE / KOD**  
**21-102-00** **THEORETICAL WEIGHTkg/m**  
*TEORİK AĞIRLIK kg/m*  
**0.230**

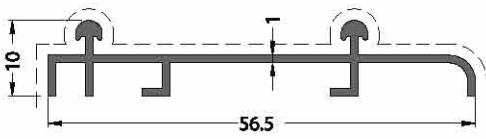

**CODE / KOD**  
**21-143-010** **THEORETICAL WEIGHTkg/m**  
*TEORİK AĞIRLIK kg/m*  
**0.273**

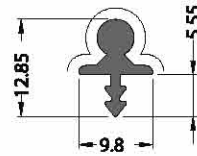

**CODE / KOD**  
**21-203-00** **THEORETICAL WEIGHTkg/m**  
*TEORİK AĞIRLIK kg/m*  
**0.120**

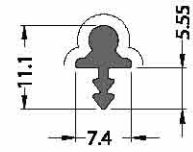

**CODE / KOD**  
**21-212-00** **THEORETICAL WEIGHTkg/m**  
*TEORİK AĞIRLIK kg/m*  
**0.089**

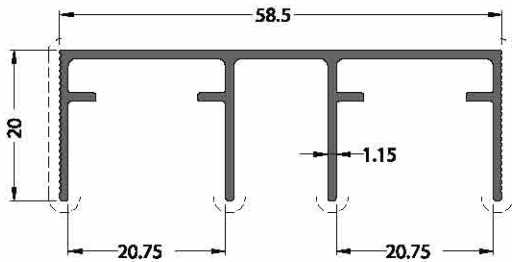

**CODE / KOD**  
**21-101-00** **THEORETICAL WEIGHTkg/m**  
*TEORİK AĞIRLIK kg/m*  
**0.454**

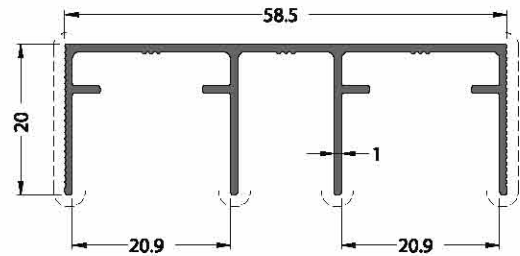

**CODE / KOD**  
**21-101i-00** **THEORETICAL WEIGHTkg/m**  
*TEORİK AĞIRLIK kg/m*  
**0.400**

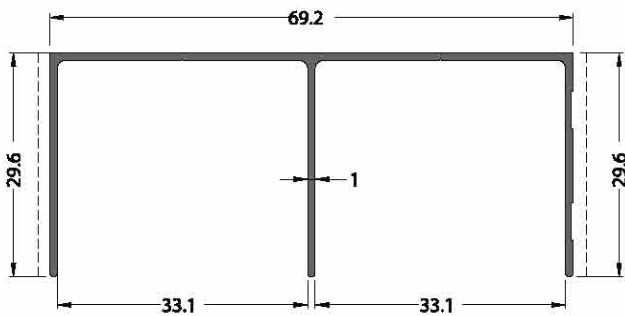

**CODE / KOD**  
**21-219-010** **THEORETICAL WEIGHTkg/m**  
*TEORİK AĞIRLIK kg/m*  
**0.416**

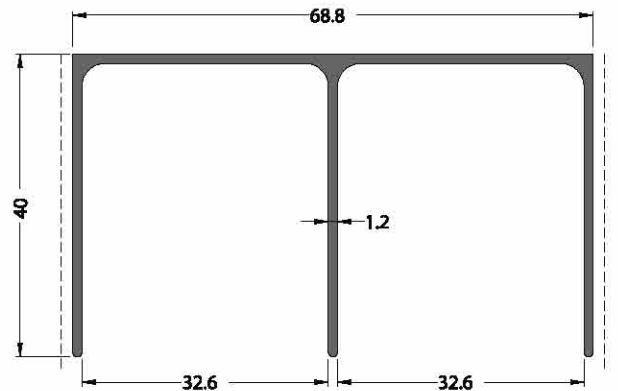

**CODE / KOD**  
**21-120-012** **THEORETICAL WEIGHTkg/m**  
*TEORİK AĞIRLIK kg/m*  
**0.622**

rayprofiles / rayprofilleri

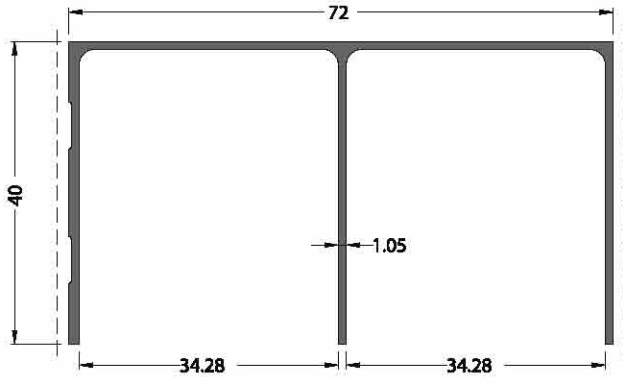

**CODE / KOD**  
**21-140-010**

**THEORETICAL WEIGHTkg/m**  
*TEORİK AĞIRLIK kg/m*  
**0.568**

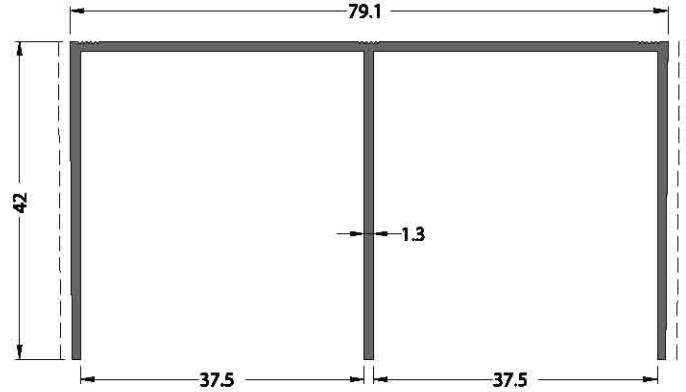

**CODE / KOD**  
**21-170-00**

**THEORETICAL WEIGHTkg/m**  
*TEORİK AĞIRLIK kg/m*  
**0.693**

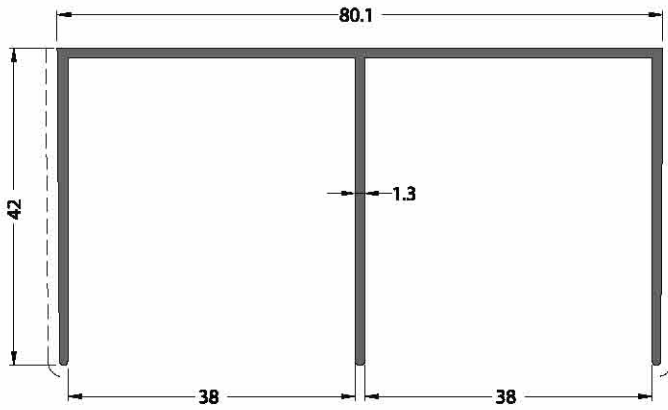

**CODE / KOD**  
**21-154-00**

**THEORETICAL WEIGHTkg/m**  
*TEORİK AĞIRLIK kg/m*  
**0.698**

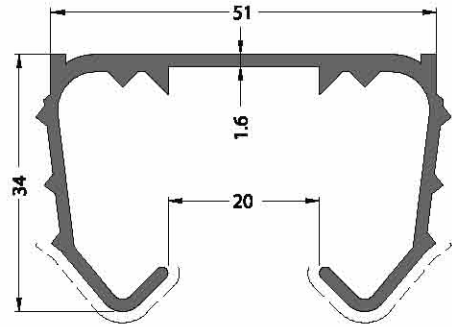

**CODE / KOD**  
**21-139-016**

**THEORETICAL WEIGHTkg/m**  
*TEORİK AĞIRLIK kg/m*  
**0.724**

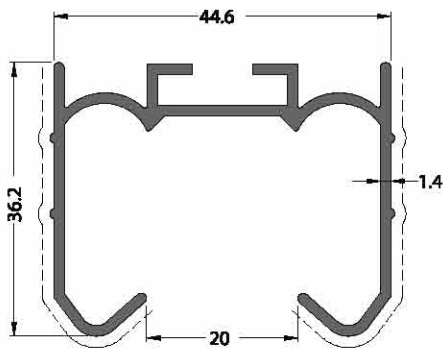

**CODE / KOD**  
**21-201-014**

**THEORETICAL WEIGHTkg/m**  
*TEORİK AĞIRLIK kg/m*  
**0.614**

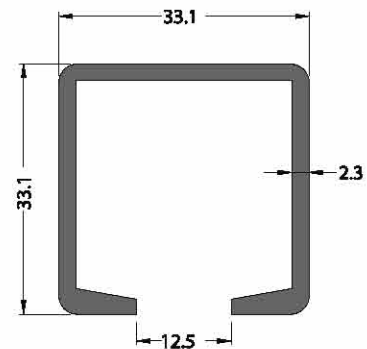

novisiblesurface / görünenyüzeyyoktur

**CODE / KOD**  
**21-235-00**

**THEORETICAL WEIGHTkg/m**  
*TEORİK AĞIRLIK kg/m*  
**0.685**

decoration&functional base profiles / alüminyum baza profilleri

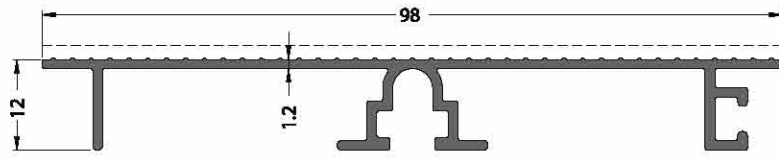

**CODE / KOD**      **THEORETICAL WEIGHTkg/m**  
**21-112-00**      *TEORİK AĞIRLIK kg/m*  
**0.579**

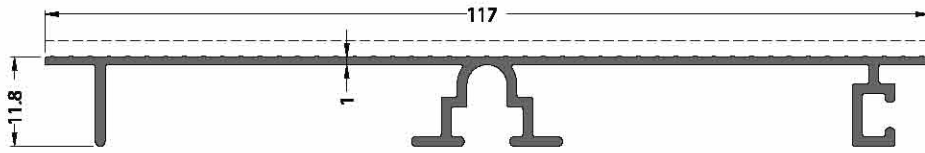

**CODE / KOD**      **THEORETICAL WEIGHTkg/m**  
**21-111-00**      *TEORİK AĞIRLIK kg/m*  
**0.575**

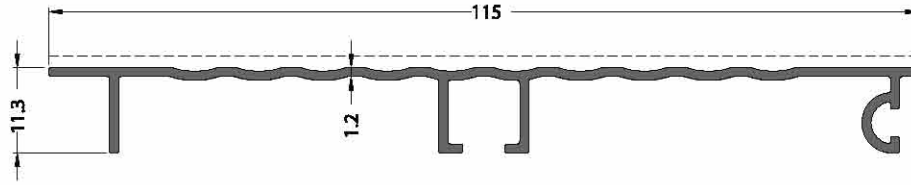

**CODE / KOD**      **THEORETICAL WEIGHTkg/m**  
**21-110-012**      *TEORİK AĞIRLIK kg/m*  
**0.540**

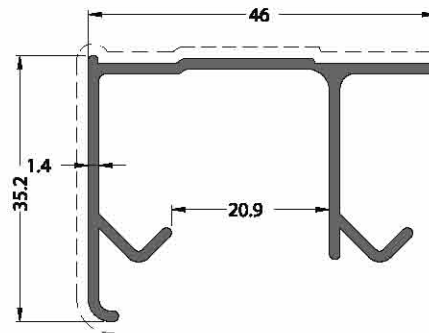

**CODE / KOD**      **THEORETICAL WEIGHTkg/m**  
**11794**      *TEORİK AĞIRLIK kg/m*  
**0.501**

Tcounterlaths / tezgaharaçitaları

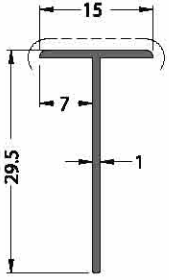

**CODE / KOD**  
**21-214-010**  
**THEORETICAL WEIGHTkg/m**  
*TEORİK AĞIRLIK kg/m*  
**0.117**

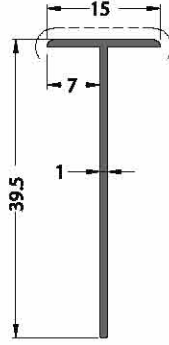

**CODE / KOD**  
**21-213-010**  
**THEORETICAL WEIGHTkg/m**  
*TEORİK AĞIRLIK kg/m*  
**0.144**

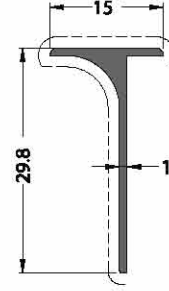

**CODE / KOD**  
**21-215-010**  
**THEORETICAL WEIGHTkg/m**  
*TEORİK AĞIRLIK kg/m*  
**0.146**

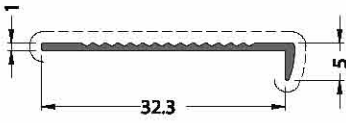

**CODE / KOD**  
**21-222-010**  
**THEORETICAL WEIGHTkg/m**  
*TEORİK AĞIRLIK kg/m*  
**0.088**

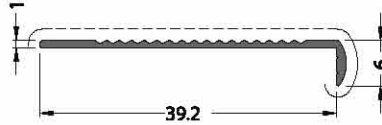

**CODE / KOD**  
**21-216-010**  
**THEORETICAL WEIGHTkg/m**  
*TEORİK AĞIRLIK kg/m*  
**0.107**

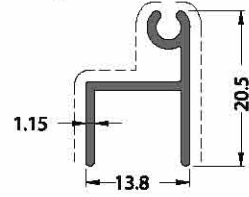

**CODE / KOD**  
**21-234-011**  
**THEORETICAL WEIGHTkg/m**  
*TEORİK AĞIRLIK kg/m*  
**0.160**

posterframeprofile / reklamprofilleri

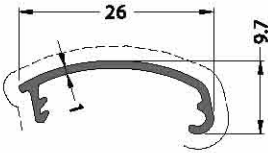

**CODE / KOD**  
**21-134-010**  
**THEORETICAL WEIGHTkg/m**  
*TEORİK AĞIRLIK kg/m*  
**0.108**

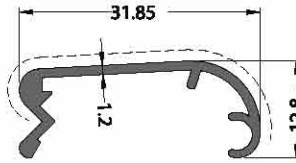

**CODE / KOD**  
**21-135-012**  
**THEORETICAL WEIGHTkg/m**  
*TEORİK AĞIRLIK kg/m*  
**0.210**

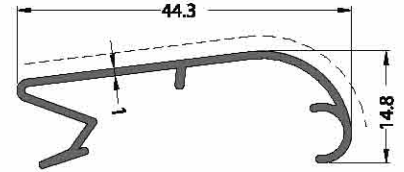

**CODE / KOD**  
**21-136-010**  
**THEORETICAL WEIGHTkg/m**  
*TEORİK AĞIRLIK kg/m*  
**0.233**

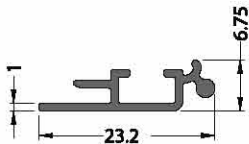

**CODE / KOD**  
**21-137-010**  
**THEORETICAL WEIGHTkg/m**  
*TEORİK AĞIRLIK kg/m*  
**0.121**

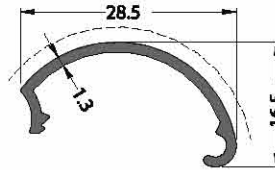

**CODE / KOD**  
**21-138-013**  
**THEORETICAL WEIGHTkg/m**  
*TEORİK AĞIRLIK kg/m*  
**0.171**

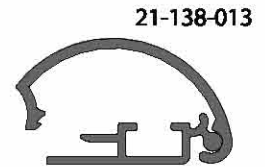

**21-138-013**  
**21-137-010**

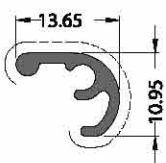

**CODE / KOD**  
**21-132-00**  
**THEORETICAL WEIGHTkg/m**  
*TEORİK AĞIRLIK kg/m*  
**0.115**

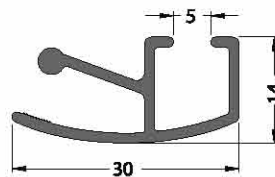

**CODE / KOD**  
**21-133-013**  
**THEORETICAL WEIGHTkg/m**  
*TEORİK AĞIRLIK kg/m*  
**0.271**



**21-132-00**  
**21-133-013**



airventcovers/amenfezprofilleri

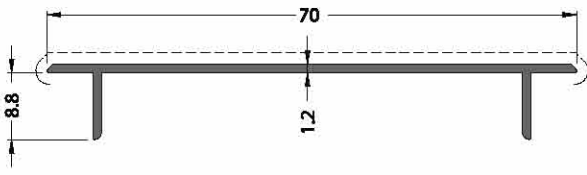

**CODE / KOD**  
**21-195-012**

**THEORETICAL WEIGHTkg/m**  
*TEORİK AĞIRLIK kg/m*  
**0.252**

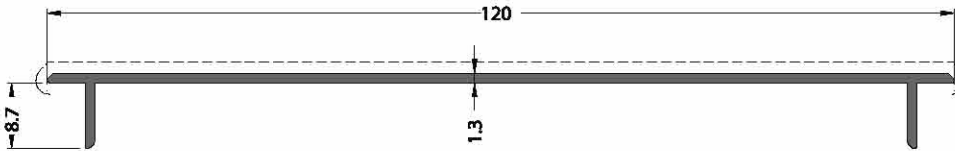

**CODE / KOD**  
**21-196-013**

**THEORETICAL WEIGHTkg/m**  
*TEORİK AĞIRLIK kg/m*  
**0.480**

chipboardsystemprofilesforendingcornering/birleřtirme-bitiř-dönüř-derzsystemprofilleri

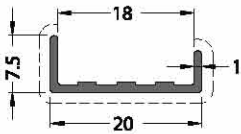

**CODE / KOD**  
**21-119-00**

**THEORETICAL WEIGHTkg/m**  
*TEORİK AĞIRLIK kg/m*  
**0.091**

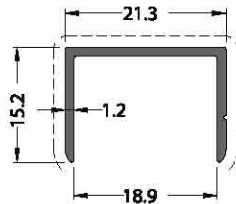

**CODE / KOD**  
**21-116-012**

**THEORETICAL WEIGHTkg/m**  
*TEORİK AĞIRLIK kg/m*  
**0.157**

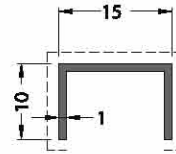

**CODE / KOD**  
**15-128-010**

**THEORETICAL WEIGHTkg/m**  
*TEORİK AĞIRLIK kg/m*  
**0.089**

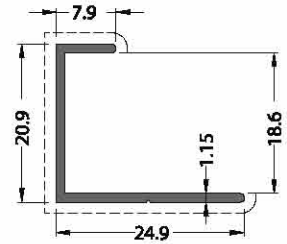

**CODE / KOD**  
**21-199-011**

**THEORETICAL WEIGHTkg/m**  
*TEORİK AĞIRLIK kg/m*  
**0.159**

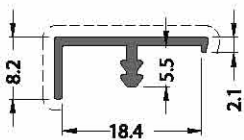

**CODE / KOD**  
**21-118-00**

**THEORETICAL WEIGHTkg/m**  
*TEORİK AĞIRLIK kg/m*  
**0.111**

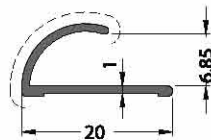

**CODE / KOD**  
**21-172-010**

**THEORETICAL WEIGHTkg/m**  
*TEORİK AĞIRLIK kg/m*  
**0.099**

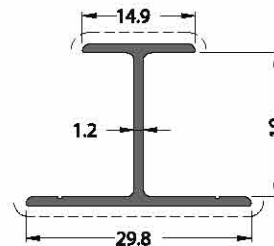

**CODE / KOD**  
**21-115-012**

**THEORETICAL WEIGHTkg/m**  
*TEORİK AĞIRLIK kg/m*  
**0.206**

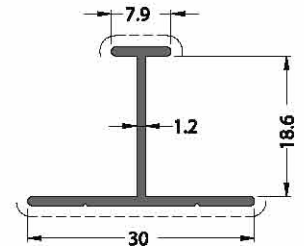

**CODE / KOD**  
**21-198-012**

**THEORETICAL WEIGHTkg/m**  
*TEORİK AĞIRLIK kg/m*  
**0.182**

hanger rods / elise askı boruları

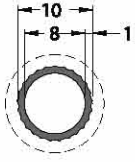

**CODE / KOD**  
**21-204-010**  
**THEORETICAL WEIGHTkg/m**  
*TEORİK AĞIRLIK kg/m*  
**0.066**

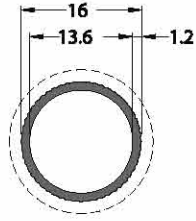

**CODE / KOD**  
**21-193-012**  
**THEORETICAL WEIGHTkg/m**  
*TEORİK AĞIRLIK kg/m*  
**0.138**

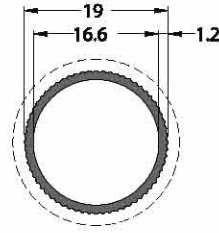

**CODE / KOD**  
**21-192-012**  
**THEORETICAL WEIGHTkg/m**  
*TEORİK AĞIRLIK kg/m*  
**0.166**

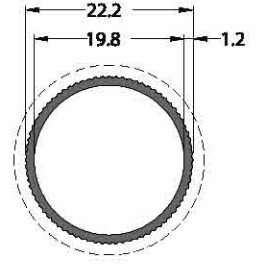

**CODE / KOD**  
**21-191-012**  
**THEORETICAL WEIGHTkg/m**  
*TEORİK AĞIRLIK kg/m*  
**0.196**

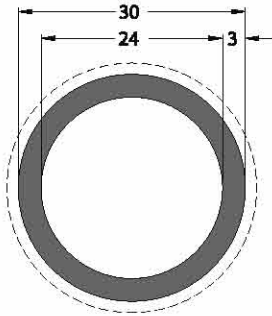

**CODE / KOD**  
**10-119-030**  
**THEORETICAL WEIGHTkg/m**  
*TEORİK AĞIRLIK kg/m*  
**0.689**

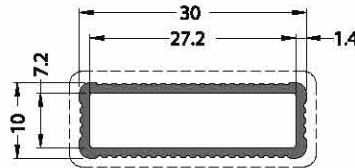

**CODE / KOD**  
**21-194-014**  
**THEORETICAL WEIGHTkg/m**  
*TEORİK AĞIRLIK kg/m*  
**0.243**

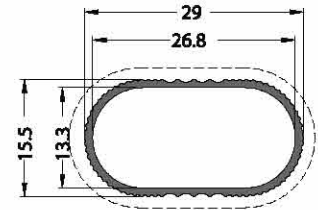

**CODE / KOD**  
**21-205-011**  
**THEORETICAL WEIGHTkg/m**  
*TEORİK AĞIRLIK kg/m*  
**0.188**

store equipment, display stand & wall shelf system profiles / mağaza ekipmanları-stand-askılık sistem profilleri

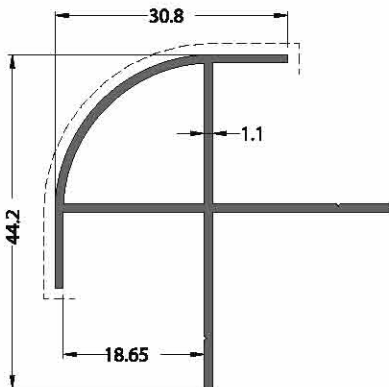

**CODE / KOD**  
**1334**  
**THEORETICAL WEIGHTkg/m**  
*TEORİK AĞIRLIK kg/m*  
**0.407**

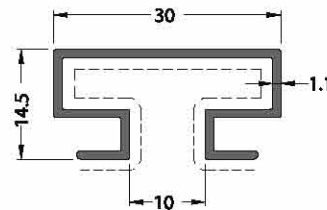

**CODE / KOD**  
**21-117-011**  
**THEORETICAL WEIGHTkg/m**  
*TEORİK AĞIRLIK kg/m*  
**0.257**

store equipment display stand & wall shelf system profiles / mağaza ekipmanları stand-askılık sistem profilleri

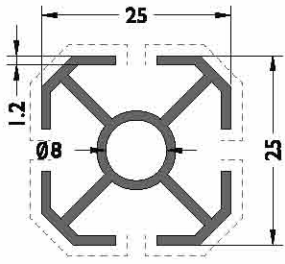

**CODE / KOD** THEORETICAL WEIGHT kg/m  
**1308** TEORİK AĞIRLIK kg/m  
 0.411

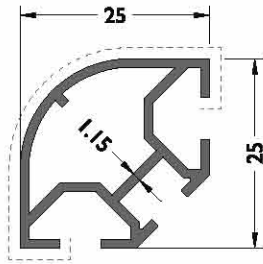

**CODE / KOD** THEORETICAL WEIGHT kg/m  
**1305** TEORİK AĞIRLIK kg/m  
 0.362

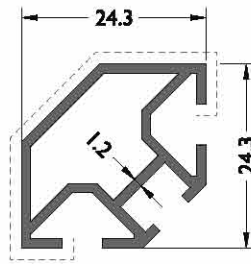

**CODE / KOD** THEORETICAL WEIGHT kg/m  
**1307** TEORİK AĞIRLIK kg/m  
 0.369

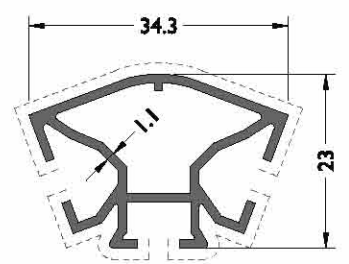

**CODE / KOD** THEORETICAL WEIGHT kg/m  
**1310** TEORİK AĞIRLIK kg/m  
 0.393

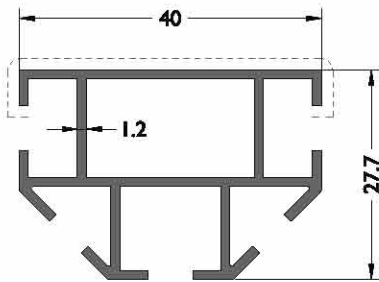

**CODE / KOD** THEORETICAL WEIGHT kg/m  
**1315** TEORİK AĞIRLIK kg/m  
 0.564

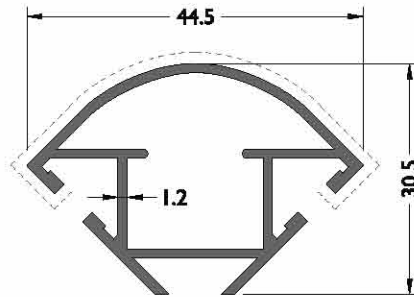

**CODE / KOD** THEORETICAL WEIGHT kg/m  
**1316** TEORİK AĞIRLIK kg/m  
 0.527

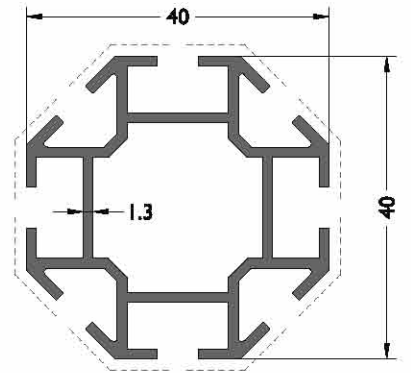

**CODE / KOD** THEORETICAL WEIGHT kg/m  
**1317** TEORİK AĞIRLIK kg/m  
 0.793

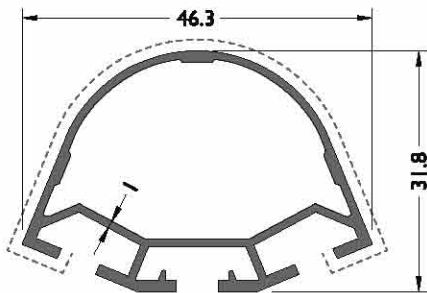

**CODE / KOD** THEORETICAL WEIGHT kg/m  
**1324** TEORİK AĞIRLIK kg/m  
 0.486

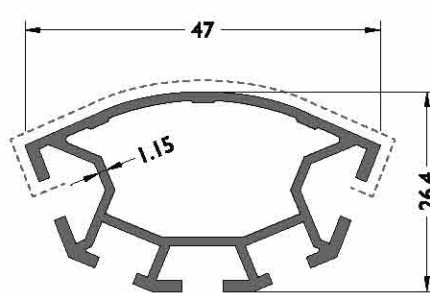

**CODE / KOD** THEORETICAL WEIGHT kg/m  
**1329** TEORİK AĞIRLIK kg/m  
 0.553

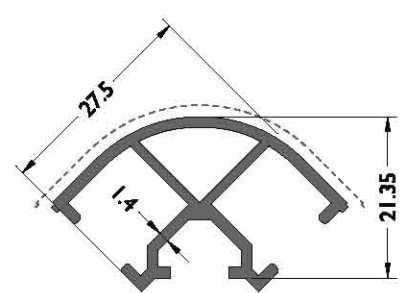

**CODE / KOD** THEORETICAL WEIGHT kg/m  
**1335** TEORİK AĞIRLIK kg/m  
 0.416

storeequipment displaystand&wallshelfsystemprofiles / mağazaekipmanları-stand-askılıksistemprofilleri

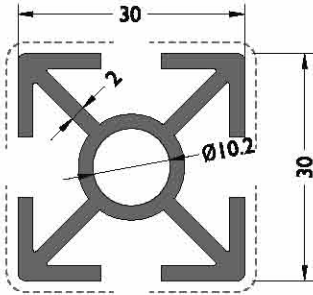

**CODE / KOD** THEORETICAL  
**1323** WEIGHT kg/m  
TEORİK AĞIRLIK kg/m  
**0.865**

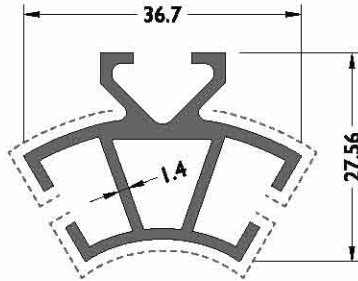

**CODE / KOD** THEORETICAL  
**1328** WEIGHT kg/m  
TEORİK AĞIRLIK kg/m  
**0.554**

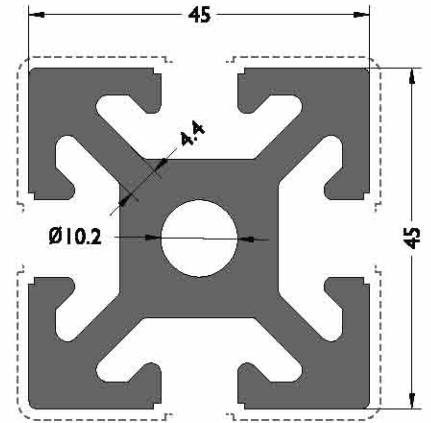

**CODE / KOD** THEORETICAL  
**1322** WEIGHT kg/m  
TEORİK AĞIRLIK kg/m  
**2.942**

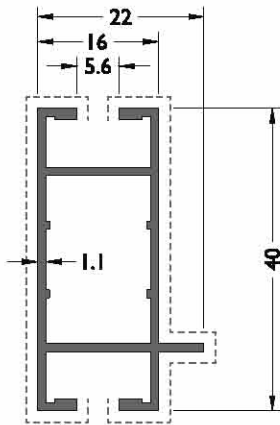

**CODE / KOD** THEORETICAL  
**1306** WEIGHT kg/m  
TEORİK AĞIRLIK kg/m  
**0.406**

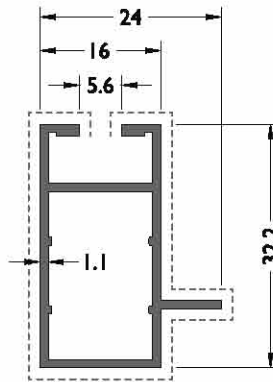

**CODE / KOD** THEORETICAL  
**1311** WEIGHT kg/m  
TEORİK AĞIRLIK kg/m  
**0.335**

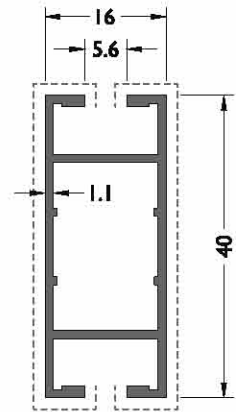

**CODE / KOD** THEORETICAL  
**1319** WEIGHT kg/m  
TEORİK AĞIRLIK kg/m  
**0.388**

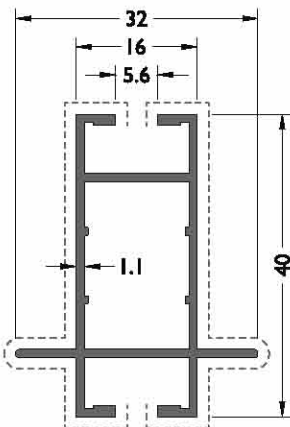

**CODE / KOD** THEORETICAL  
**1320** WEIGHT kg/m  
TEORİK AĞIRLIK kg/m  
**0.435**

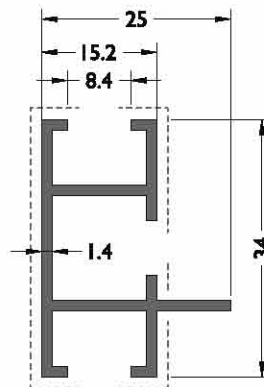

**CODE / KOD** THEORETICAL  
**1336** WEIGHT kg/m  
TEORİK AĞIRLIK kg/m  
**0.392**

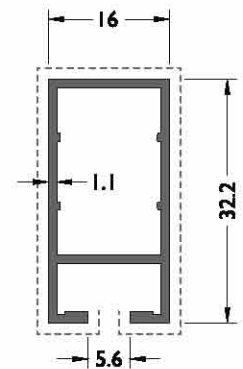

**CODE / KOD** THEORETICAL  
**1331** WEIGHT kg/m  
TEORİK AĞIRLIK kg/m  
**0.311**

store equipment display stand & wall shelf system profiles / mağaza ekipmanları stand-askılık sistem profilleri

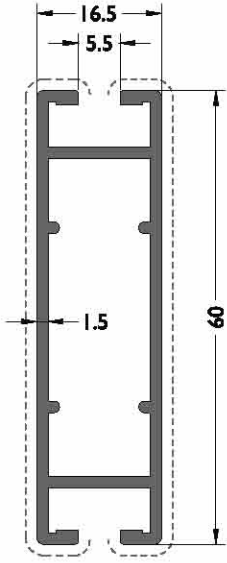

**CODE / KOD**  
**1321**  
**THEORETICAL WEIGHT kg/m**  
*TEORİK AĞIRLIK kg/m*  
**0.694**

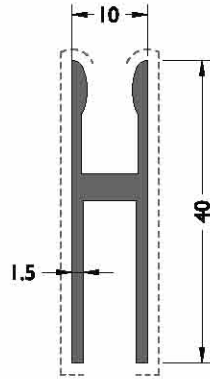

**CODE / KOD**  
**1312**  
**THEORETICAL WEIGHT kg/m**  
*TEORİK AĞIRLIK kg/m*  
**0.390**

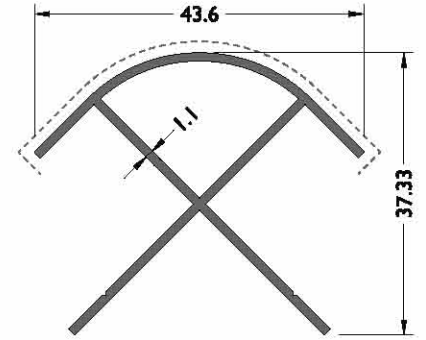

**CODE / KOD**  
**1334**  
**THEORETICAL WEIGHT kg/m**  
*TEORİK AĞIRLIK kg/m*  
**0.407**

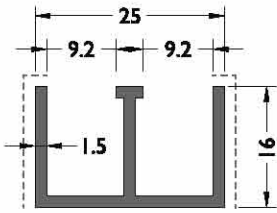

**CODE / KOD**  
**1313**  
**THEORETICAL WEIGHT kg/m**  
*TEORİK AĞIRLIK kg/m*  
**0.287**

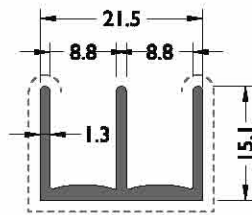

**CODE / KOD**  
**1327**  
**THEORETICAL WEIGHT kg/m**  
*TEORİK AĞIRLIK kg/m*  
**0.247**

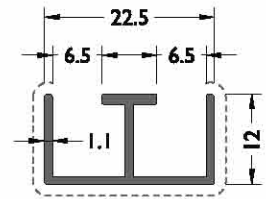

**CODE / KOD**  
**1332**  
**THEORETICAL WEIGHT kg/m**  
*TEORİK AĞIRLIK kg/m*  
**0.187**

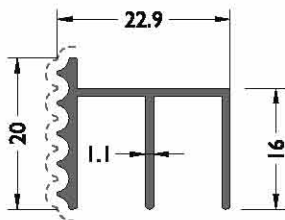

**CODE / KOD**  
**1195**  
**THEORETICAL WEIGHT kg/m**  
*TEORİK AĞIRLIK kg/m*  
**0.236**

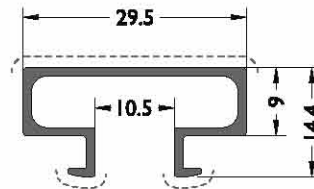

**CODE / KOD**  
**1333**  
**THEORETICAL WEIGHT kg/m**  
*TEORİK AĞIRLIK kg/m*  
**0.238**

*blackbordprofiles / yazıtahtasıprofilleri*

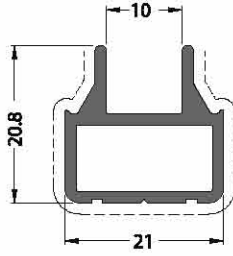

**CODE / KOD**  
**12199**  
**THEORETICAL WEIGHT kg/m**  
*TEORİK AĞIRLIK kg/m*  
**0.331**

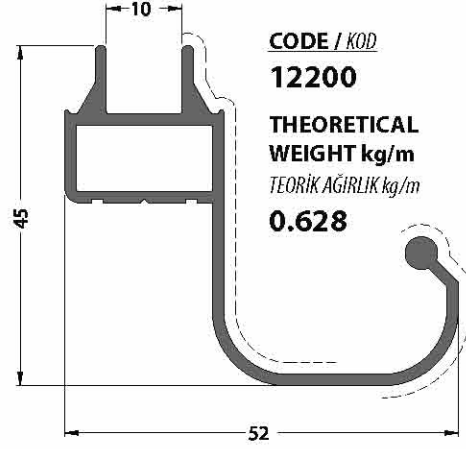

**CODE / KOD**  
**12200**  
**THEORETICAL WEIGHT kg/m**  
*TEORİK AĞIRLIK kg/m*  
**0.628**

*otherprofiles / diğerprofiller*

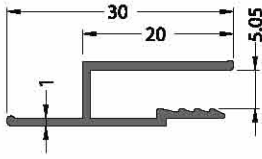

no visible surface  
görünmeyen yüzey yoktur

**CODE / KOD**  
**21-181-010**  
**THEORETICAL WEIGHT kg/m**  
*TEORİK AĞIRLIK kg/m*  
**0.162**

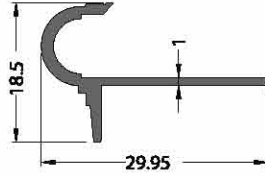

no visible surface  
görünmeyen yüzey yoktur

**CODE / KOD**  
**21-150-00**  
**THEORETICAL WEIGHT kg/m**  
*TEORİK AĞIRLIK kg/m*  
**0.175**

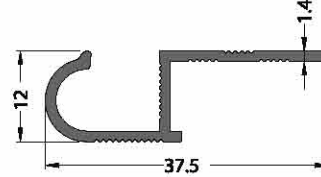

no visible surface  
görünmeyen yüzey yoktur

**CODE / KOD**  
**21-151-014**  
**THEORETICAL WEIGHT kg/m**  
*TEORİK AĞIRLIK kg/m*  
**0.218**

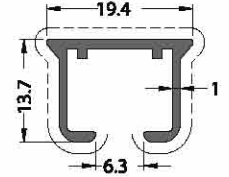

**CODE / KOD**  
**21-163-00**  
**THEORETICAL WEIGHT kg/m**  
*TEORİK AĞIRLIK kg/m*  
**0.168**

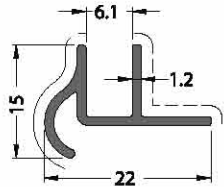

**CODE / KOD**  
**21-146-012**  
**THEORETICAL WEIGHT kg/m**  
*TEORİK AĞIRLIK kg/m*  
**0.160**

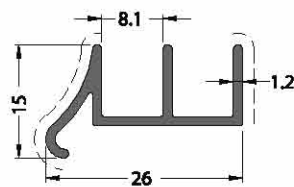

**CODE / KOD**  
**21-147-012**  
**THEORETICAL WEIGHT kg/m**  
*TEORİK AĞIRLIK kg/m*  
**0.203**

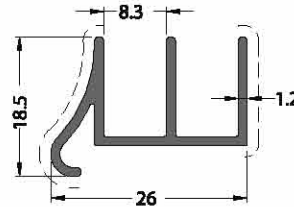

**CODE / KOD**  
**21-148-012**  
**THEORETICAL WEIGHT kg/m**  
*TEORİK AĞIRLIK kg/m*  
**0.247**

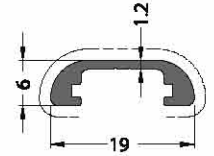

**CODE / KOD**  
**21-131-00**  
**THEORETICAL WEIGHT kg/m**  
*TEORİK AĞIRLIK kg/m*  
**0.126**

*other profiles / diğer profiller*

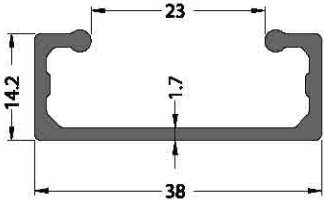

novisible surface  
görünmeyen yüzey yoktur

**CODE / KOD**

**21-108-00**

**THEORETICAL WEIGHT kg/m**

*TEORİK AĞIRLIK kg/m*

**0.369**

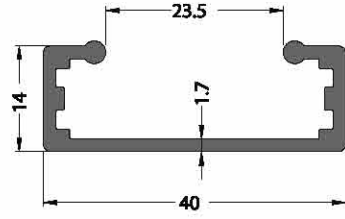

novisible surface  
görünmeyen yüzey yoktur

**CODE / KOD**

**21-188-00**

**THEORETICAL WEIGHT kg/m**

*TEORİK AĞIRLIK kg/m*

**0.409**

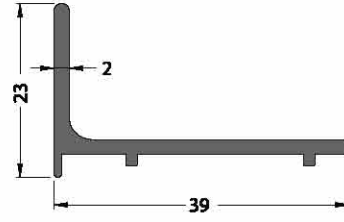

novisible surface  
görünmeyen yüzey yoktur

**CODE / KOD**

**21-109-00**

**THEORETICAL WEIGHT kg/m**

*TEORİK AĞIRLIK kg/m*

**0.332**

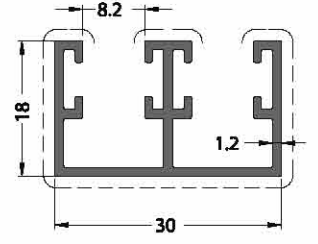

**CODE / KOD**

**21-173-012**

**THEORETICAL WEIGHT kg/m**

*TEORİK AĞIRLIK kg/m*

**0.363**

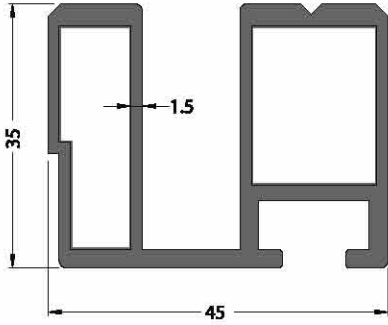

novisible surface / görünmeyen yüzey yoktur

**CODE / KOD**

**21-149-00**

**THEORETICAL WEIGHT kg/m**

*TEORİK AĞIRLIK kg/m*

**1.092**

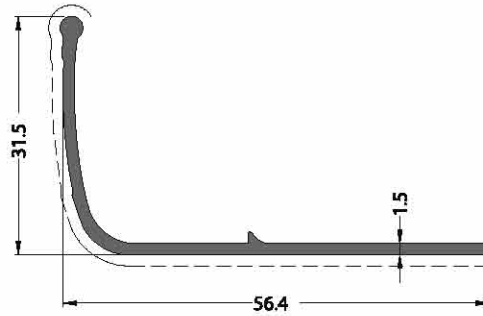

**CODE / KOD**

**21-183-015**

**THEORETICAL WEIGHT kg/m**

*TEORİK AĞIRLIK kg/m*

**0.353**

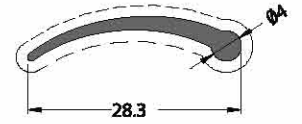

**CODE / KOD**

**21-175-00**

**THEORETICAL WEIGHT kg/m**

*TEORİK AĞIRLIK kg/m*

**0.150**

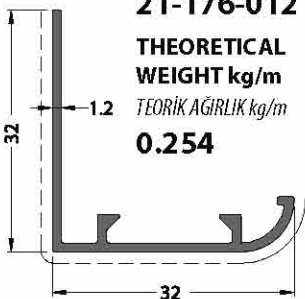

**CODE / KOD**

**21-176-012**

**THEORETICAL WEIGHT kg/m**

*TEORİK AĞIRLIK kg/m*

**0.254**

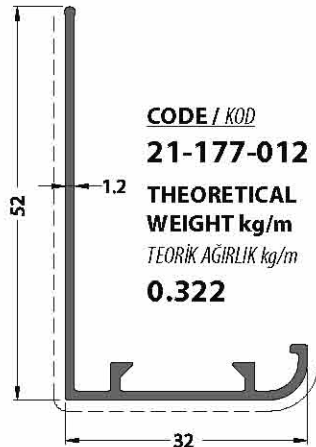

**CODE / KOD**

**21-177-012**

**THEORETICAL WEIGHT kg/m**

*TEORİK AĞIRLIK kg/m*

**0.322**

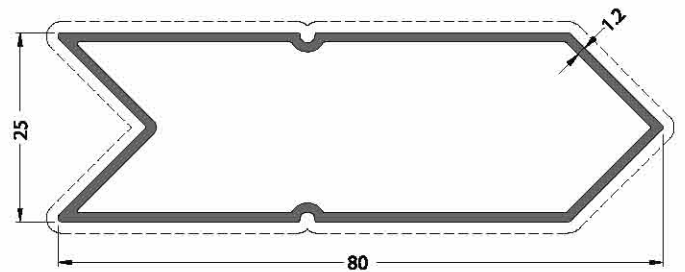

**CODE / KOD**

**21-178-012**

**THEORETICAL WEIGHT kg/m**

*TEORİK AĞIRLIK kg/m*

**0.659**

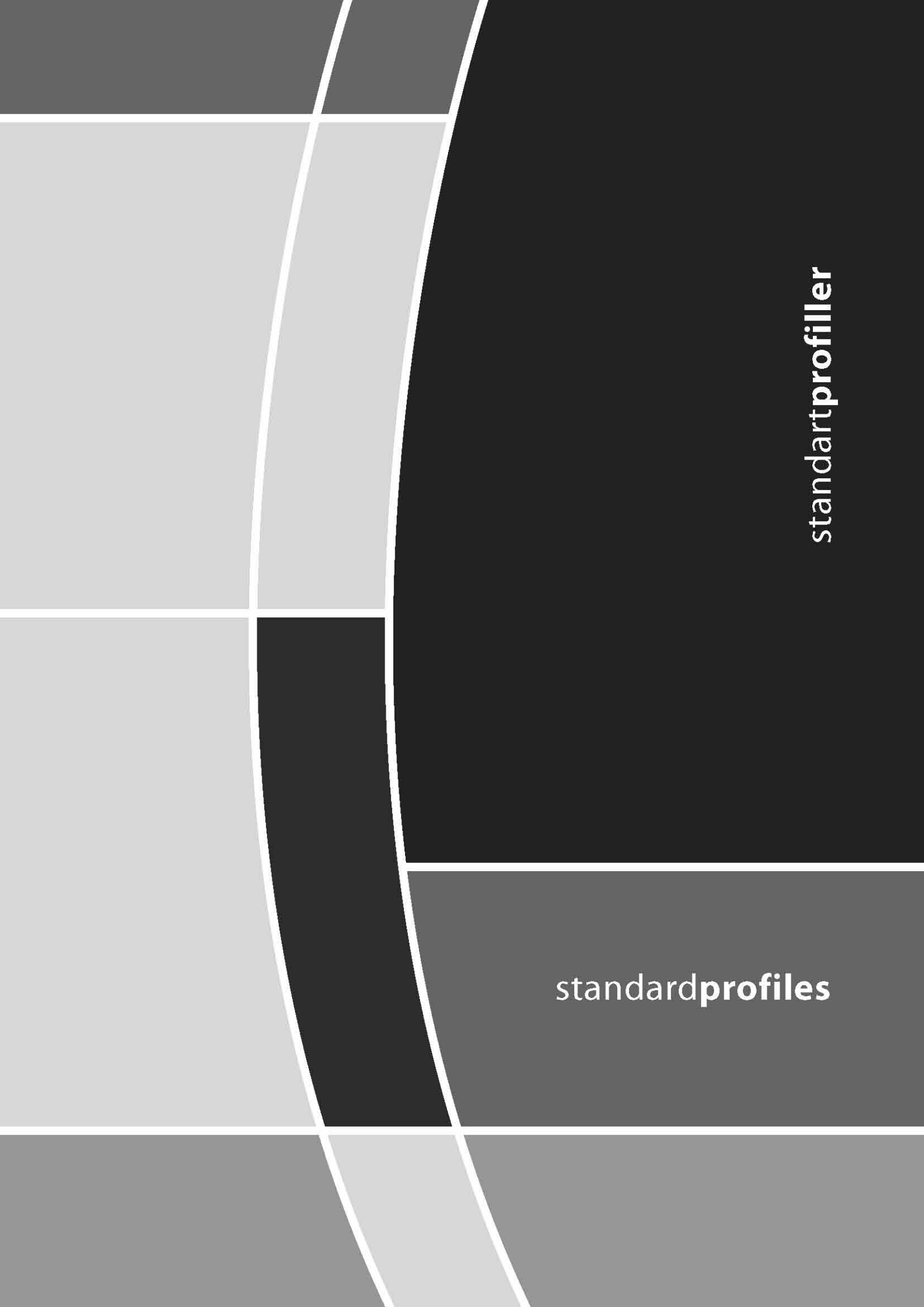

standart**profiler**

standard**profiles**



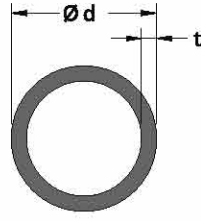

pipe profiles / boru profilleri

Ø d (mm)	t (mm)	Agırlık (kg/m)	Profil No	Ø d (mm)	t (mm)	Agırlık (kg/m)	Profil No
Ø 12	1	0,093	10-140-010	Ø 30	3,75	0,838	10-119-037
Ø 15	2,75	0,287	10-101-027	Ø 30	4	0,885	10-119-040
Ø 15,7	2,25	0,257	10-102-022	Ø 30	10	1,703	10-119-100
Ø 16	1,5	0,185	10-103-015	Ø 31	6,2	1,309	10-120-062
Ø 16	2	0,238	10-103-020	Ø 32	2	0,511	10-121-020
Ø 16	4	0,408	10-103-040	Ø 32	3	0,741	10-121-030
Ø 16	5	0,468	10-103-050	Ø 35	2,5	0,692	10-122-025
Ø 18	2	0,272	10-104-020	Ø 35	3	0,817	10-122-030
Ø 18,7	1,1	0,165	10-105-011	Ø 35	3,25	0,878	10-122-032
Ø 19	1,2	0,182	10-106-012	Ø 35	13,5	2,471	10-122-135
Ø 19	1,5	0,223	10-106-015	Ø 35,5	14,5	2,592	10-123-145
Ø 19,2	1,5	0,222	10-107-015	Ø 38	3	0,894	10-138-030
Ø 20	1	0,162	10-108-010	Ø 40	1	0,332	10-124-010
Ø 20	1,8	0,279	10-108-018	Ø 40	2,5	0,798	10-124-025
Ø 20	3	0,434	10-108-030	Ø 40	5	1,490	10-124-050
Ø 20	4	0,545	10-108-040	Ø 40	10	2,554	10-124-100
Ø 20,4	1,2	0,196	10-109-012	Ø 40,2	15,1	3,227	10-125-151
Ø 20,5	3	0,447	10-137-030	Ø 40,5	16,35	3,362	10-126-163
Ø 21	4,5	0,632	10-110-045	Ø 43	1,5	0,530	10-127-015
Ø 21,7	1,1	0,193	10-111-011	Ø 50	1,5	0,619	10-128-015
Ø 22	1,2	0,212	10-112-012	Ø 50	1,8	0,738	10-128-018
Ø 22	1,5	0,262	10-112-015	Ø 50	2	0,817	10-128-020
Ø 22	2,5	0,415	10-112-025	Ø 50	2,5	1,011	10-128-025
Ø 22	5	0,724	10-112-050	Ø 50	3	1,200	10-128-030
Ø 22,2	1,2	0,218	10-141-012	Ø 50	4	1,566	10-128-040
Ø 22,5	1,5	0,268	10-137-015	Ø 50	10,5	3,531	10-128-105
Ø 24	3,75	0,646	10-113-037	Ø 50,15	20,57	5,180	10-129-205
Ø 24	5	0,809	10-113-050	Ø 54	1,8	0,800	10-130-018
Ø 24,7	1,1	0,221	10-114-011	Ø 55	2,3	1,032	10-131-023
Ø 25	1,5	0,300	10-115-015	Ø 55	7,25	2,947	10-132-072
Ø 25	2	0,392	10-115-020	Ø 60	1,5	0,747	10-132-015

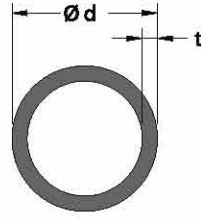

pipeprofiles / boruprofilleri

Ø d (mm)	t (mm)	Agırlık (kg/m)	Profil No	Ø d (mm)	t (mm)	Agırlık (kg/m)	Profil No
Ø 25	3,25	0,602	10-115-032	Ø 60	2	0,988	10-132-020
Ø 25	8,25	1,176	10-115-082	Ø 60	2,5	1,224	10-132-025
Ø 26	2	0,409	10-116-020	Ø 60	3	1,456	10-132-030
Ø 28	2,8	0,601	10-117-028	Ø 60	5	2,341	10-132-050
Ø 28	4,7	0,932	10-117-047	Ø 65	7	3,456	10-133-070
Ø 29,5	2	0,468	10-118-020	Ø 70	1,5	0,875	10-134-015
Ø 30	2,2	0,521	10-119-022	Ø 75	5	2,980	10-135-050
Ø 30	2,5	0,585	10-119-025	Ø 82	4	2,656	10-136-040
Ø 30	3	0,689	10-119-030	Ø 101,8	1,8	1,532	10-139-018

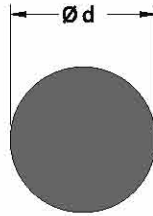

solidprofiles / doluprofililer

Ø d (mm)	Agırlık (kg/m)	Profil No	Ø d (mm)	Agırlık (kg/m)	Profil No
Ø 10	0,213	11-112-00	Ø 35	2,607	11-105-00
Ø 12	0,306	11-113-00	Ø 40	3,405	11-106-00
Ø 16	0,545	11-101-00	Ø 45	4,310	11-107-00
Ø 20	0,851	11-102-00	Ø 50	5,321	11-108-00
Ø 22	1,030	11-103-00	Ø 56	6,675	11-110-00
Ø 25	1,330	11-114-00	Ø 60	7,662	11-109-00
Ø 26	1,439	11-115-00	Ø 70	10,429	11-111-00
Ø 30	1,915	11-104-00			

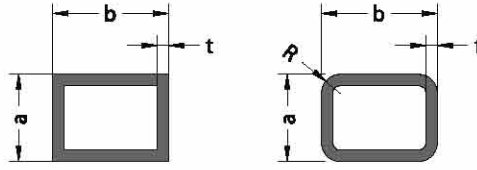

box profiles / kutu profilleri

a (mm)	b (mm)	t (mm)	Agirlik (kg/m)	Profil No
10	10	1,8	0,160	12-147-018
10	20	1,5	0,220	12-134-015
11,2	42	1,3	0,356	12-151-013
12	12	2	0,211	12-141-020R
12	18	1,1	0,150	12-155-011
12	20	1,5	0,231	12-156-015R
12	50	1,3	0,418	12-133-013
14	14	2	0,258	12-153-020R
15	15	2	0,282	12-101-020
15	30	1	0,233	12-102-010
15	30	1	0,219	12-102-010R
15	30	1,2	0,261	12-102-012R
15	30	1,3	0,299	12-102-013
15	80	1,4	0,700	12-150-014
17	25	1	0,217	12-103-010
17	25	1,2	0,257	12-103-012
18	18	1	0,184	12-159-010
18,6	28,8	1,1	0,255	12-142-011R
18,6	29	1,1	0,266	12-146-011R
20	20	1,3	0,263	12-104-013
20	30	1,5	0,382	12-148-015
20	40	1	0,314	12-105-010
20	40	1,2	0,375	12-105-012
20	40	1,5	0,463	12-105-015
20	40	2	0,607	12-105-020
20	45	3	0,959	12-158-030R
20	60	1,2	0,505	12-106-012
20	80	1,4	0,737	12-107-014
20	80	2	1,041	12-107-020
20	100	1,4	0,899	12-108-014
20	120	1,5	1,114	12-109-015
20,6	39,8	0,8	0,255	12-154-008
22	60	1,5	0,640	12-129-015R
25	25	1,3	0,334	12-110-013
27	27	2	0,521	12-130-020R

a (mm)	b (mm)	t (mm)	Agirlik (kg/m)	Profil No
30	30	1,3	0,404	12-111-013
30	30	1,5	0,452	12-111-015R
30	30	3	0,862	12-111-030R
30	40	1,2	0,440	12-112-012
30	40	1,8	0,648	12-112-018
30	50	1,5	0,626	12-149-015
30	100	1,5	1,033	12-113-015R
32	70	1,3	0,700	12-114-013
32	75	1,5	0,846	12-115-015
39,1	49	2	0,912	12-116-020
40	40	1	0,423	12-117-010
40	40	1,2	0,505	12-117-012
40	40	1,5	0,626	12-117-015
40	40	2	0,824	12-117-020
40	40	2,5	1,007	12-117-025R
40	50	1	0,477	12-118-010
40	50	1,2	0,570	12-118-012
40	60	1,25	0,660	12-119-012
40	60	3	1,528	12-119-030
40	60	4	1,995	12-119-040
40	80	1,5	0,951	12-120-015
40	80	2	1,257	12-120-020
40	80	3,2	1,970	12-120-032
40	100	1,5	1,114	12-135-015
40	120	1,8	1,525	12-136-018
40	140	4	3,729	12-156-040
44,6	60	3	1,603	12-121-030
45	45	1,8	0,843	12-122-018
49,2	128	2,2	2,060	12-143-022
49,3	89,6	1,6	1,177	12-144-016
50	50	1,6	0,840	12-123-016
50	50	3	1,528	12-123-030
50	80	5	3,252	12-145-050
50	95	1,6	1,230	12-124-016
50	95	2	1,528	12-124-020

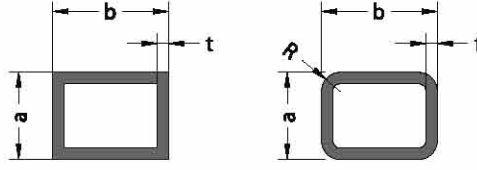

boxprofiles / kutuprofilleri

a (mm)	b (mm)	t (mm)	Agirlik (kg/m)	Profil No
50	120	5	4,336	12-125-050
54	54	1,2	0,687	12-140-012
55,15	55,15	2	1,152	12-139-020
60	60	1,3	0,827	12-126-013
65	45	3	1,654	12-160-030R
70	70	1,5	1,114	12-127-015
80	80	1,5	1,276	12-137-015

a (mm)	b (mm)	t (mm)	Agirlik (kg/m)	Profil No
80	120	3	3,154	12-157-030
90	90	2	1,908	12-128-020
90	90	5	4,502	12-128-050R
100	100	2	2,124	12-138-020
109,5	59,5	4	3,397	12-152-040R
110	110	2	2,108	12-131-020R
150	50	3	3,154	12-132-030

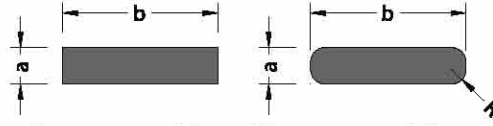

lamaprofiles / lama profilleri

a (mm)	b (mm)	Agirlik (kg/m)	Profil No
4,4	19,5	0,233	13-135-044
9,8	5	0,118	13-134-050R
10	10	0,271	13-101-100
10	18,5	0,501	13-101-185
13	3	0,103	13-102-030R
14	3	0,114	13-103-030
20	3	0,163	13-104-030
20	3	0,157	13-104-030R
20	4	0,207	13-104-040R
20	6	0,304	13-136-060R
22	35	2,087	13-105-350
23	2,5	0,156	13-106-025
23,7	23,7	1,522	13-107-237
25	3	0,203	13-108-030
25	4	0,271	13-108-040
25	6	0,385	13-108-060R
28	5	0,380	13-109-050
30	5	0,406	13-110-050

a (mm)	b (mm)	Agirlik (kg/m)	Profil No
30	6	0,467	13-110-060R
38,5	3,5	0,365	13-140-035
40	2	0,217	13-111-020
40	3	0,325	13-111-030
40	3	0,320	13-111-030R
40	6	0,629	13-111-060R
40	40	4,336	13-111-400
46	2	0,249	13-141-020
50	3	0,407	13-112-030
50	6	0,792	13-112-060R
50	10	1,355	13-112-100
55	3	0,442	13-113-030R
55	5	0,678	13-113-050
55	6	0,873	13-113-060R
59	5	0,799	13-114-050
60	3	0,488	13-115-030
60	10	1,626	13-115-100
62,5	6	0,995	13-138-060R

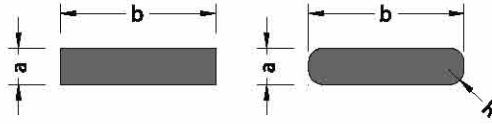

lama profiles / lama profilleri

a (mm)	b (mm)	Agırlık (kg/m)	Profil No	a (mm)	b (mm)	Agırlık (kg/m)	Profil No
65	30	5,284	13-116-300	100	18	4,878	13-122-180
69,9	5,9	1,099	13-117-059R	109,9	5,9	1,737	13-123-059R
70	3	0,564	13-133-030R	110	3	0,889	13-124-030R
74,9	6,9	1,374	13-118-069R	110	5	1,490	13-124-050
75	3	0,604	13-118-030R	124,9	5,9	1,978	13-125-059R
75	3,55	0,714	13-118-035R	125	3	1,011	13-125-030R
75	6	1,198	13-118-060R	129,9	3,9	1,365	13-126-039R
80	2	0,433	13-119-020R	129,9	6,9	2,403	13-126-069R
80	3	0,645	13-119-030R	130	3	1,054	13-126-030R
80	4	0,867	13-119-040	140	3	1,133	13-127-030R
80	5,9	1,259	13-118-059R	140	6	2,255	13-127-060R
80	6,9	1,468	13-119-069R	159,9	5,9	2,538	13-128-059R
80	10	2,168	13-119-100	159,9	6,9	2,964	13-128-069R
80	20	4,336	13-119-200	160	3	1,295	13-128-030R
87,5	5	1,179	13-120-050	170	4	1,843	13-129-040
99,9	3,55	0,954	13-121-035R	186	3,5	1,764	13-130-035
99,9	5,9	1,579	13-121-059R	199,9	5,9	3,117	13-131-059R
99,9	6,9	1,842	13-121-069R	200	20	10,840	13-132-200
100	10	2,710	13-122-100	250	6	4,044	13-137-060R

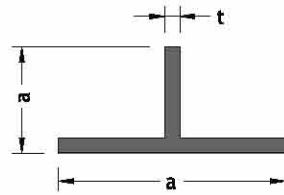

t profiles / t profiller

a (mm)	b (mm)	(mm)	Agırlık (kg/m)	Profil No	a (mm)	b (mm)	(mm)	Agırlık (kg/m)	Profil No
20	20	1,2	0,126	16-101-012	30	30	1,5	0,238	16-103-015
25	25	1,2	0,159	16-102-012	50	50	2	0,530	16-104-020
25	25	1,5	0,197	16-102-015	50	70	2	0,640	16-105-020
25	25	2	0,260	16-102-020	59,5	100	4	1,556	16-106-040
30	30	1,2	0,191	16-103-012	60	80	2	0,748	16-107-020

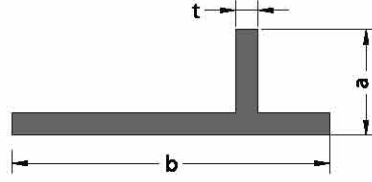

asymmetric profiles / asimetric profiller

a(mm)	b(mm)	(mm)	Agirlik(kg/m)	Profil No
20	40	1,2	0,191	17-101-012

a(mm)	b(mm)	(mm)	Agirlik(kg/m)	Profil No
25	50	1,2	0,240	17-102-012

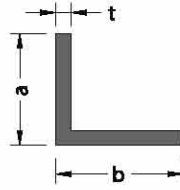

corner profiles / köşebent profilleri

a (mm)	b (mm)	t (mm)	Agirlik (kg/m)	Profil No
7	35	2,8	0,297	14-101-028
10	10	1,2	0,061	14-102-012
10	15	1,2	0,077	14-103-012
10	20	1,5	0,115	14-126-015
12	25	3	0,276	14-104-030
13	15	2	0,141	14-105-020
14	22	2,3	0,210	14-129-023
15	15	1,2	0,093	14-106-012
15	15	1,5	0,116	14-106-015
15	20	3	0,260	14-134-030
20	20	1,2	0,126	14-107-012
20	20	1,5	0,156	14-107-015
20	30	1,3	0,172	14-108-013
20	30	2,75	0,352	14-108-027
20	40	1,2	0,191	14-109-012
20	40	3	0,463	14-109-030
20	50	1,2	0,224	14-110-012
20	50	1,4	0,260	14-110-014
20	60	1,3	0,277	14-111-013
20	70	1,3	0,312	14-112-013
20	80	1,3	0,348	14-113-013
20	80	2	0,531	14-113-020
20	100	1,5	0,482	14-114-015
20	120	1,5	0,563	14-115-015
25	25	1,2	0,159	14-116-012
25	25	1,5	0,197	14-116-015

a (mm)	b (mm)	t (mm)	Agirlik (kg/m)	Profil No
25	25	2	0,260	14-116-020
25	25	4	0,498	14-116-040
25	80	1,5	0,421	14-117-015
27	27	7	0,891	14-128-070
30	30	1,2	0,191	14-118-012
30	30	1,5	0,238	14-118-015
30	30	3	0,463	14-118-030
40	40	1,2	0,256	14-119-012
40	40	1,5	0,319	14-119-015
40	40	2	0,423	14-119-020
40	40	3	0,626	14-119-030
40	40	4	0,824	14-119-040
40	40	4,8	0,978	14-119-048
40	40	6	1,203	14-120-060
40	60	1,3	0,348	14-121-013
40	80	1,5	0,482	14-122-015
40	80	3	0,951	14-122-030
45	45	5	1,152	14-123-050
50	50	1,5	0,400	14-124-015
50	50	4	1,041	14-124-040
60	30	3	0,688	14-133-030R
60	70	1,8	0,625	14-127-018
60	185	3	1,967	14-130-030
70	103	3	1,358	14-125-030
75	75	3,5	1,362	14-132-035R
200	40	4	2,558	14-131-040

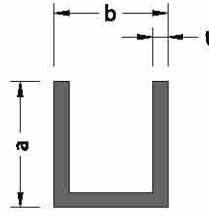

u profiles / u profilleri

a (mm)	b (mm)	t (mm)	Agırlık (kg/m)	Profil No
10	10	1	0,076	15-125-010
10	15	1	0,089	15-128-010
10	25	4	0,398	15-116-040R
10	60	1,2	0,252	15-101-012
10	60	1,6	0,332	15-101-016
15	17	0,9	0,110	15-102-009
15	50	1,2	0,251	15-118-012
16	12	1,3	0,145	15-117-013
17	15	1,2	0,151	15-103-012
17	17	1	0,132	15-104-010
20	8	2	0,230	15-123-020R
20	15	2	0,276	15-105-020
20	18	1,2	0,181	15-106-012
20	19	1,5	0,228	15-107-015
20	20	2	0,303	15-127-020
24	38	1,8	0,401	15-108-018

a (mm)	b (mm)	t (mm)	Agırlık (kg/m)	Profil No
25	8	2,5	0,354	15-119-025
25	20	2	0,358	15-112-020
25	20	4	0,672	15-112-040
28	14,3	1,2	0,220	15-121-012
28	28	1,5	0,329	15-122-015
30	30	1,5	0,354	15-109-015
30	30	2	0,466	15-124-020
30	40	3	0,764	15-114-030
30	120	2	0,954	15-115-020
30	170	2	1,224	15-116-020
40	30	1,5	0,435	15-110-015
40	34	3	0,869	15-111-030
40	51	1	0,350	15-120-010
45	45	2	0,710	15-128-010
45	55	2	0,764	15-126-020
47	45	5	1,737	15-115-050R

**halı-merdivenvefayansprofilleri**

**carpet-stairsandtileprofiles**



## carpet-stairs and tile profiles / halı-merdiven ve fayans profilleri

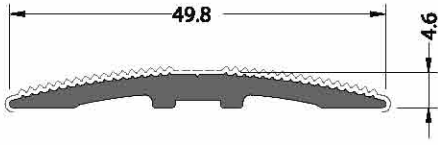

**CODE / KOD**  
**20-101-00**

**THEORETICAL WEIGHT kg/m**  
*TEORİK AĞIRLIK kg/m*  
**0.355**

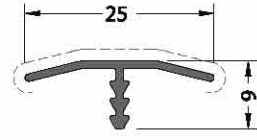

**CODE / KOD**  
**20-102-00**

**THEORETICAL WEIGHT kg/m**  
*TEORİK AĞIRLIK kg/m*  
**0.103**

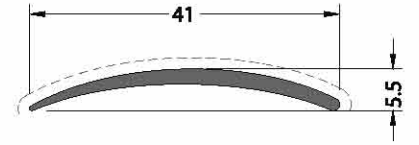

**CODE / KOD**  
**20-103-00**

**THEORETICAL WEIGHT kg/m**  
*TEORİK AĞIRLIK kg/m*  
**0.190**

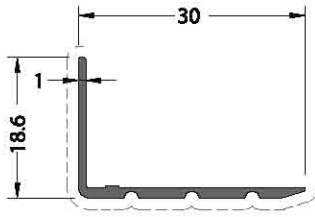

**CODE / KOD**  
**20-104-00**

**THEORETICAL WEIGHT kg/m**  
*TEORİK AĞIRLIK kg/m*  
**0.145**

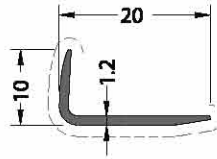

**CODE / KOD**  
**20-105-00**

**THEORETICAL WEIGHT kg/m**  
*TEORİK AĞIRLIK kg/m*  
**0.083**

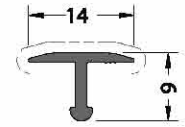

**CODE / KOD**  
**20-106-00**

**THEORETICAL WEIGHT kg/m**  
*TEORİK AĞIRLIK kg/m*  
**0.076**

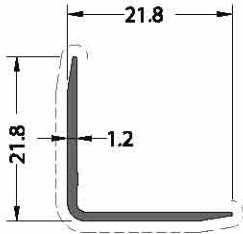

**CODE / KOD**  
**20-107-00**

**THEORETICAL WEIGHT kg/m**  
*TEORİK AĞIRLIK kg/m*  
**0.127**

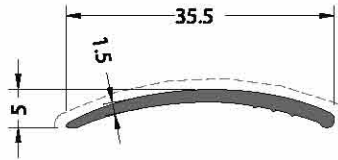

**CODE / KOD**  
**20-108-00**

**THEORETICAL WEIGHT kg/m**  
*TEORİK AĞIRLIK kg/m*  
**0.153**

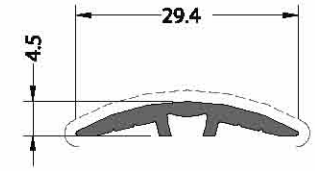

**CODE / KOD**  
**20-109-00**

**THEORETICAL WEIGHT kg/m**  
*TEORİK AĞIRLIK kg/m*  
**0.175**

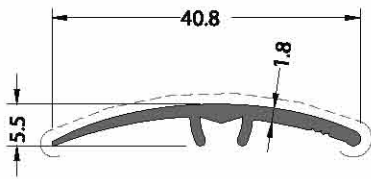

**CODE / KOD**  
**20-110-00**

**THEORETICAL WEIGHT kg/m**  
*TEORİK AĞIRLIK kg/m*  
**0.198**

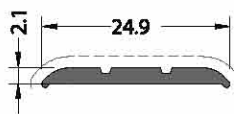

**CODE / KOD**  
**20-111-00**

**THEORETICAL WEIGHT kg/m**  
*TEORİK AĞIRLIK kg/m*  
**0.127**

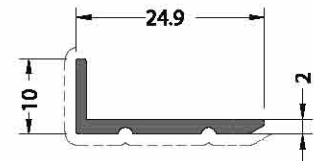

**CODE / KOD**  
**20-112-00**

**THEORETICAL WEIGHT kg/m**  
*TEORİK AĞIRLIK kg/m*  
**0.152**

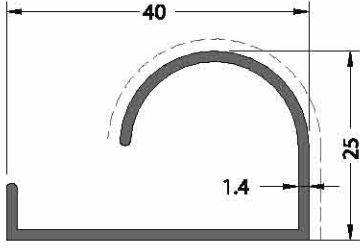

CODE / KOD

20-113-014

THEORETICAL WEIGHT kg/m

TEORİK AĞIRLIK kg/m

0.355

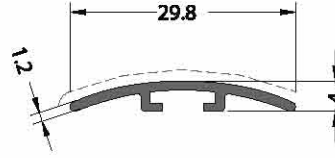

CODE / KOD

20-114-00

THEORETICAL WEIGHT kg/m

TEORİK AĞIRLIK kg/m

0.123

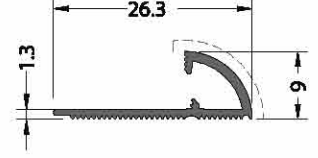

CODE / KOD

20-115-00

THEORETICAL WEIGHT kg/m

TEORİK AĞIRLIK kg/m

0.118

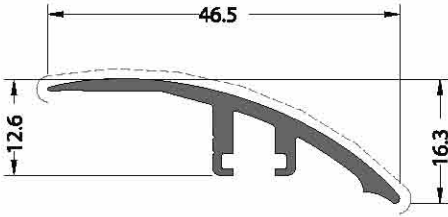

CODE / KOD

20-116-00

THEORETICAL WEIGHT kg/m

TEORİK AĞIRLIK kg/m

0.312

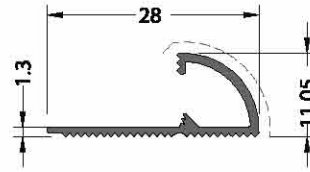

CODE / KOD

20-117-00

THEORETICAL WEIGHT kg/m

TEORİK AĞIRLIK kg/m

0.133

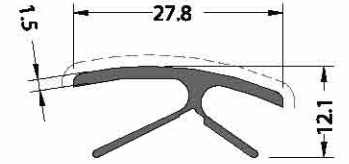

CODE / KOD

20-118-00

THEORETICAL WEIGHT kg/m

TEORİK AĞIRLIK kg/m

0.194

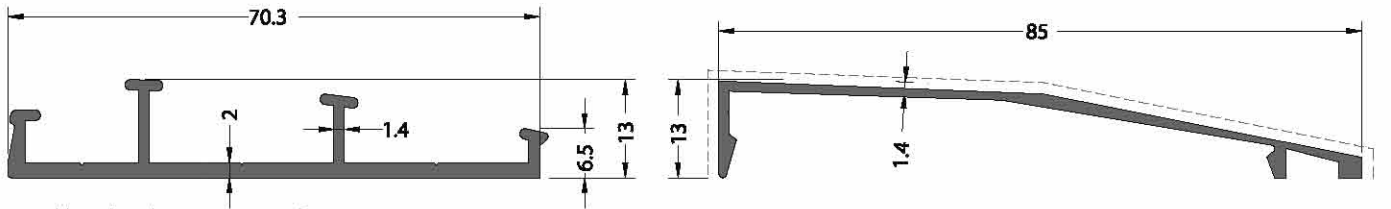

no visible surface / görünmeyen yüzey yoktur

CODE / KOD

20-119-00

THEORETICAL WEIGHT kg/m

TEORİK AĞIRLIK kg/m

0.547

CODE / KOD

20-120-00

THEORETICAL WEIGHT kg/m

TEORİK AĞIRLIK kg/m

0.408

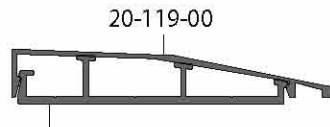

20-119-00  
20-120-00 scale 1/2 / ölçek 1/2

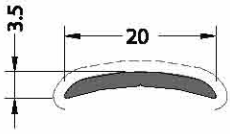

**CODE / KOD**  
**20-121-00**

**THEORETICAL WEIGHT kg/m**  
*TEORİK AĞIRLIK kg/m*  
**0.097**

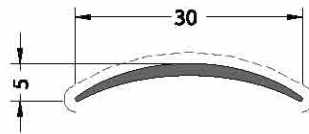

**CODE / KOD**  
**20-122-00**

**THEORETICAL WEIGHT kg/m**  
*TEORİK AĞIRLIK kg/m*  
**0.106**

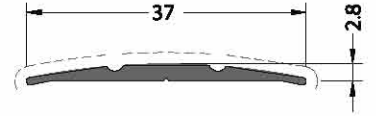

**CODE / KOD**  
**20-123-00**

**THEORETICAL WEIGHT kg/m**  
*TEORİK AĞIRLIK kg/m*  
**0.123**

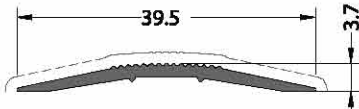

**CODE / KOD**  
**20-124-00**

**THEORETICAL WEIGHT kg/m**  
*TEORİK AĞIRLIK kg/m*  
**0.157**

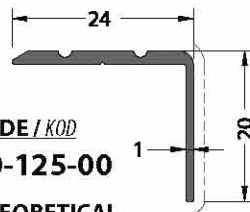

**CODE / KOD**  
**20-125-00**

**THEORETICAL WEIGHT kg/m**  
*TEORİK AĞIRLIK kg/m*  
**0.152**

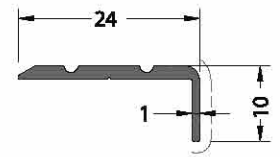

**CODE / KOD**  
**20-126-00**

**THEORETICAL WEIGHT kg/m**  
*TEORİK AĞIRLIK kg/m*  
**0.125**

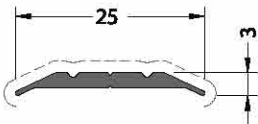

**CODE / KOD**  
**20-127-00**

**THEORETICAL WEIGHT kg/m**  
*TEORİK AĞIRLIK kg/m*  
**0.103**

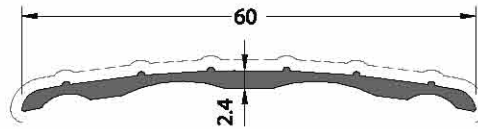

**CODE / KOD**  
**20-128-00**

**THEORETICAL WEIGHT kg/m**  
*TEORİK AĞIRLIK kg/m*  
**0.299**

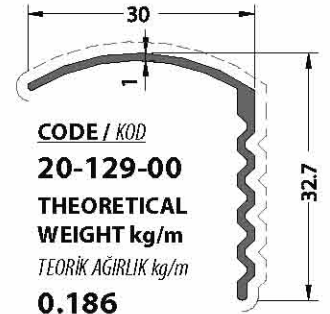

**CODE / KOD**  
**20-129-00**

**THEORETICAL WEIGHT kg/m**  
*TEORİK AĞIRLIK kg/m*  
**0.186**

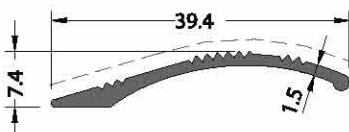

**CODE / KOD**  
**20-130-00**

**THEORETICAL WEIGHT kg/m**  
*TEORİK AĞIRLIK kg/m*  
**0.183**

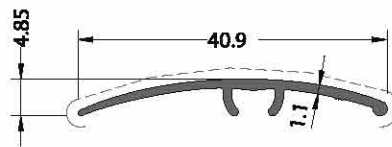

**CODE / KOD**  
**20-131-00**

**THEORETICAL WEIGHT kg/m**  
*TEORİK AĞIRLIK kg/m*  
**0.144**

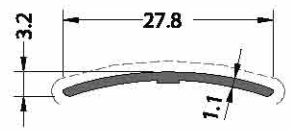

**CODE / KOD**  
**20-132-00**

**THEORETICAL WEIGHT kg/m**  
*TEORİK AĞIRLIK kg/m*  
**0.086**

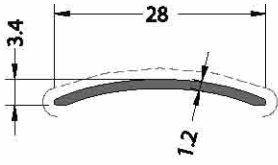

CODE / KOD

**20-133-012**

**THEORETICAL WEIGHT kg/m**

TEORİK AĞIRLIK kg/m

**0.090**

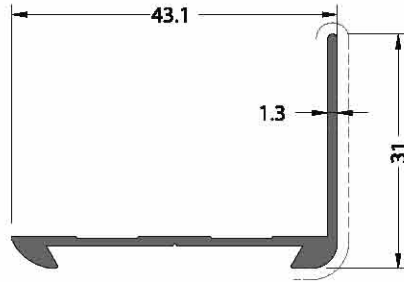

CODE / KOD

**20-134-00**

**THEORETICAL WEIGHT kg/m**

TEORİK AĞIRLIK kg/m

**0.295**

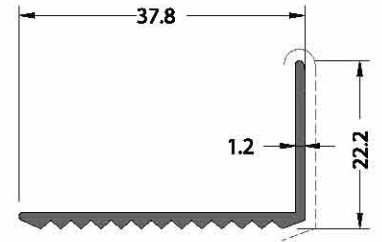

CODE / KOD

**20-135-00**

**THEORETICAL WEIGHT kg/m**

TEORİK AĞIRLIK kg/m

**0.222**

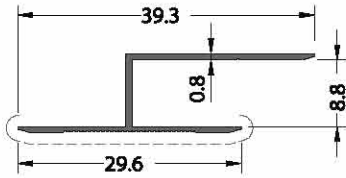

CODE / KOD

**20-136-00**

**THEORETICAL WEIGHT kg/m**

TEORİK AĞIRLIK kg/m

**0.129**

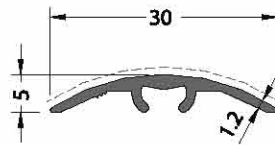

CODE / KOD

**20-137-00**

**THEORETICAL WEIGHT kg/m**

TEORİK AĞIRLIK kg/m

**0.140**

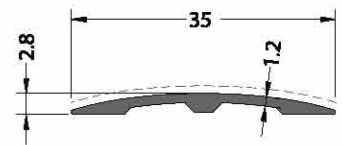

CODE / KOD

**20-138-00**

**THEORETICAL WEIGHT kg/m**

TEORİK AĞIRLIK kg/m

**0.133**

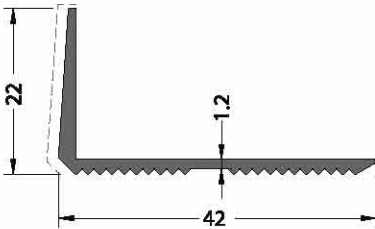

CODE / KOD

**20-139-00**

**THEORETICAL WEIGHT kg/m**

TEORİK AĞIRLIK kg/m

**0.259**

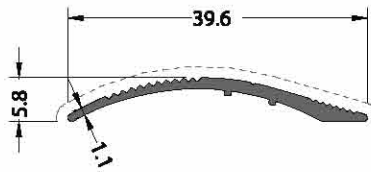

CODE / KOD

**20-140-00**

**THEORETICAL WEIGHT kg/m**

TEORİK AĞIRLIK kg/m

**0.158**

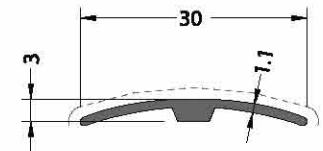

CODE / KOD

**20-141-00**

**THEORETICAL WEIGHT kg/m**

TEORİK AĞIRLIK kg/m

**0.115**

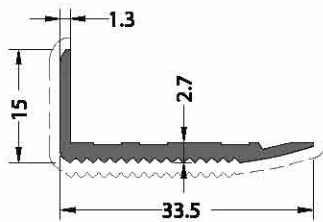

CODE / KOD

**20-142-00**

**THEORETICAL WEIGHT kg/m**

TEORİK AĞIRLIK kg/m

**0.225**

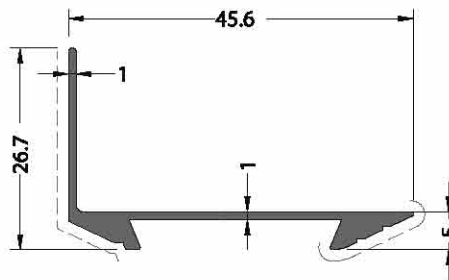

CODE / KOD

**20-143-00**

**THEORETICAL WEIGHT kg/m**

TEORİK AĞIRLIK kg/m

**0.287**

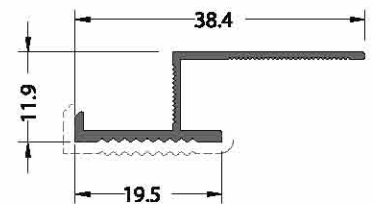

CODE / KOD

**20-144-00**

**THEORETICAL WEIGHT kg/m**

TEORİK AĞIRLIK kg/m

**0.162**

## carpet-stairsandtileprofiles / halı-merdivenvefayansprofilleri

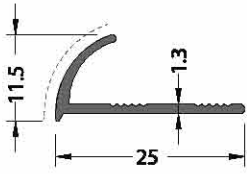

**CODE / KOD**  
**20-145-00**

**THEORETICAL WEIGHT kg/m**  
*TEORİK AĞIRLIK kg/m*  
**0.158**

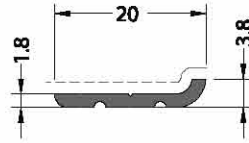

**CODE / KOD**  
**20-146-00**

**THEORETICAL WEIGHT kg/m**  
*TEORİK AĞIRLIK kg/m*  
**0.093**

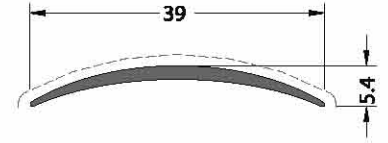

**CODE / KOD**  
**20-148-00**

**THEORETICAL WEIGHT kg/m**  
*TEORİK AĞIRLIK kg/m*  
**0.150**

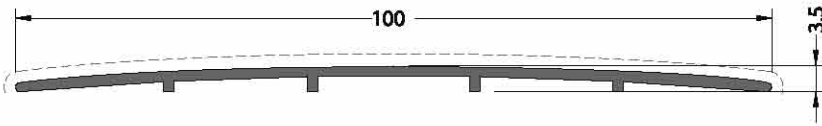

**CODE / KOD**  
**20-147-00**

**THEORETICAL WEIGHT kg/m**  
*TEORİK AĞIRLIK kg/m*  
**0.386**

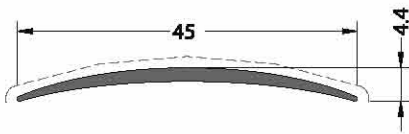

**CODE / KOD**  
**20-149-00**

**THEORETICAL WEIGHT kg/m**  
*TEORİK AĞIRLIK kg/m*  
**0.171**

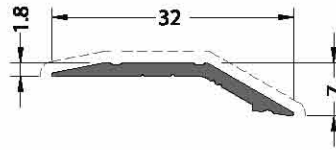

**CODE / KOD**  
**20-150-00**

**THEORETICAL WEIGHT kg/m**  
*TEORİK AĞIRLIK kg/m*  
**0.142**

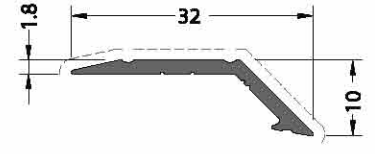

**CODE / KOD**  
**20-151-00**

**THEORETICAL WEIGHT kg/m**  
*TEORİK AĞIRLIK kg/m*  
**0.159**

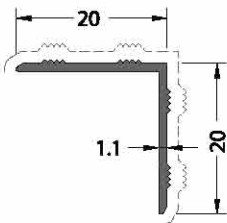

**CODE / KOD**  
**20-152-00**

**THEORETICAL WEIGHT kg/m**  
*TEORİK AĞIRLIK kg/m*  
**0.121**

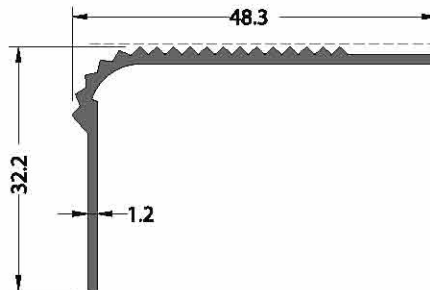

**CODE / KOD**  
**20-153-00**

**THEORETICAL WEIGHT kg/m**  
*TEORİK AĞIRLIK kg/m*  
**0.307**

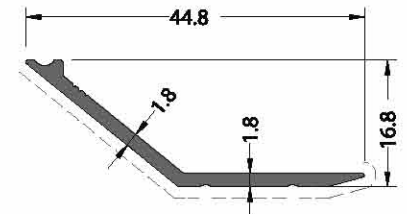

**CODE / KOD**  
**20-154-00**

**THEORETICAL WEIGHT kg/m**  
*TEORİK AĞIRLIK kg/m*  
**0.233**

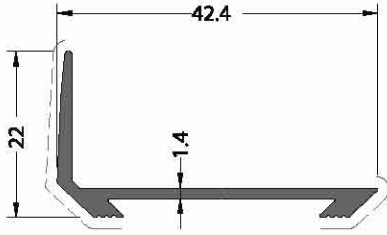

**CODE / KOD**  
**20-155-00**

**THEORETICAL WEIGHT kg/m**  
*TEORİK AĞIRLIK kg/m*  
**0.285**

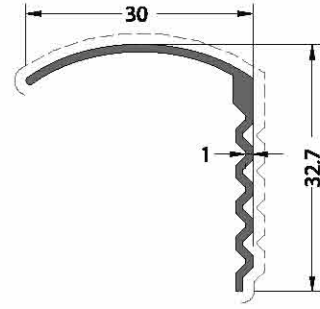

**CODE / KOD**  
**20-156-00**

**THEORETICAL WEIGHT kg/m**  
*TEORİK AĞIRLIK kg/m*  
**0.190**

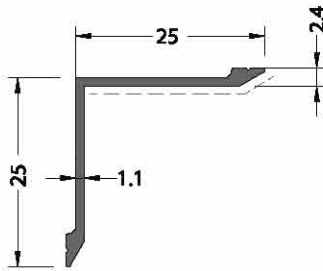

**CODE / KOD**  
**20-157-00**

**THEORETICAL WEIGHT kg/m**  
*TEORİK AĞIRLIK kg/m*  
**0.160**

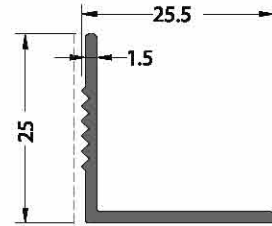

**CODE / KOD**  
**20-158-00**

**THEORETICAL WEIGHT kg/m**  
*TEORİK AĞIRLIK kg/m*  
**0.197**

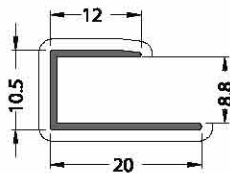

**CODE / KOD**  
**21-130-009**

**THEORETICAL WEIGHT kg/m**  
*TEORİK AĞIRLIK kg/m*  
**0.095**



Produced by 

**KURTOGLU BAKIR KURŞUN SAN. A.Ş.**  
İstasyon Mahallesi Akbayır Mevkii Kümesi  
No:81 Velimeşe Çorlu 59851 Tekirdağ / Türkiye  
P: +90 282 684 70 00 F: +90 282 684 70 01  
[www.kurtogluas.com](http://www.kurtogluas.com) [kurtoglu@kurtogluas.com](mailto:kurtoglu@kurtogluas.com)

 **Lorenzoline®**  
aluminium profile system